



Atmel 8-bit AVR Microcontroller with 2K Bytes In-System Programmable Flash

ATtiny261A

Appendix A and B – ATtiny261A Specification at 105°C and 125°C

This document contains information specific to devices operating at temperatures up to 125°C. Only deviations are covered in this appendix, all other information can be found in the complete datasheet. The complete datasheet can be found at www.atmel.com.

1. Electrical Characteristics

1.1 Absolute Maximum Ratings*

Operating Temperature	-55°C to +125°C
Storage Temperature	-65°C to +150°C
Voltage on any Pin except $\overline{\text{RESET}}$ with respect to Ground	-0.5V to $V_{\text{CC}}+0.5\text{V}$
Voltage on $\overline{\text{RESET}}$ with respect to Ground	-0.5V to +13.0V
Maximum Operating Voltage	6.0V
DC Current per I/O Pin	40.0mA
DC Current V_{CC} and GND Pins	200.0mA

*NOTICE: Stresses beyond those listed under “Absolute Maximum Ratings” may cause permanent damage to the device. This is a stress rating only and functional operation of the device at these or other conditions beyond those indicated in the operational sections of this specification is not implied. Exposure to absolute maximum rating conditions for extended periods may affect device reliability.

1.2 DC Characteristics

Table 1-1. DC Characteristics. $T_A = -40^\circ\text{C}$ to $+125^\circ\text{C}$, $V_{\text{CC}} = 1.8\text{V}$ to 5.5V (unless otherwise noted).

Symbol	Parameter	Condition	Min	Typ ⁽¹⁾	Max	Units
V_{IL}	Input Low-voltage	Except XTAL1 and $\overline{\text{RESET}}$ pins	-0.5		$0.2V_{\text{CC}}$ ⁽³⁾	V
		XTAL1 pin, External Clock Selected	-0.5		$0.1V_{\text{CC}}$ ⁽³⁾	V
		$\overline{\text{RESET}}$ pin	-0.5		$0.2V_{\text{CC}}$ ⁽³⁾	V
		$\overline{\text{RESET}}$ pin as I/O	-0.5		$0.2V_{\text{CC}}$ ⁽³⁾	V
V_{IH}	Input High-voltage	Except XTAL1 and $\overline{\text{RESET}}$ pins	$0.7V_{\text{CC}}$ ⁽²⁾		$V_{\text{CC}} + 0.5$	V
		XTAL1 pin, External Clock Selected	$0.8V_{\text{CC}}$ ⁽²⁾		$V_{\text{CC}} + 0.5$	V
		$\overline{\text{RESET}}$ pin	$0.9V_{\text{CC}}$ ⁽²⁾		$V_{\text{CC}} + 0.5$	V
		$\overline{\text{RESET}}$ pin as I/O	$0.7V_{\text{CC}}$ ⁽²⁾		$V_{\text{CC}} + 0.5$	V
V_{OL}	Output Low Voltage ⁽⁴⁾ (Except Reset pin) ⁽⁶⁾	$I_{\text{OL}} = 10\text{mA}$, $V_{\text{CC}} = 5\text{V}$			0.6	V
		$I_{\text{OL}} = 5\text{mA}$, $V_{\text{CC}} = 3\text{V}$			0.5	V
V_{OH}	Output High-voltage ⁽⁵⁾ (Except Reset pin) ⁽⁶⁾	$I_{\text{OH}} = -10\text{mA}$, $V_{\text{CC}} = 5\text{V}$	4.3			V
		$I_{\text{OH}} = -5\text{mA}$, $V_{\text{CC}} = 3\text{V}$	2.5			V
I_{IL}	Input Leakage Current I/O Pin	$V_{\text{CC}} = 5.5\text{V}$, pin low (absolute value)		< 0.05	1	μA
I_{IH}	Input Leakage Current I/O Pin	$V_{\text{CC}} = 5.5\text{V}$, pin high (absolute value)		< 0.05	1	μA
R_{RST}	Reset Pull-up Resistor		30		60	$\text{k}\Omega$
R_{PU}	I/O Pin Pull-up Resistor		20		50	$\text{k}\Omega$

Table 1-1. DC Characteristics. $T_A = -40^{\circ}\text{C}$ to $+125^{\circ}\text{C}$, $V_{CC} = 1.8\text{V}$ to 5.5V (unless otherwise noted). (Continued)

Symbol	Parameter	Condition	Min	Typ ⁽¹⁾	Max	Units
I_{CC}	Power Supply Current ⁽⁷⁾	Active 1MHz, $V_{CC} = 2\text{V}$		0.2	0.5	mA
		Active 4MHz, $V_{CC} = 3\text{V}$		1.2	2	mA
		Active 8MHz, $V_{CC} = 5\text{V}$		3.6	7	mA
		Idle 1MHz, $V_{CC} = 2\text{V}$		0.035	0.15	mA
		Idle 4MHz, $V_{CC} = 3\text{V}$		0.25	0.4	mA
		Idle 8MHz, $V_{CC} = 5\text{V}$		0.9	1.5	mA
	Power-down mode ⁽⁸⁾	WDT enabled, $V_{CC} = 3\text{V}$		4	20	μA
		WDT disabled, $V_{CC} = 3\text{V}$		0.2	10	μA

- Notes:
1. Typical values at 25°C .
 2. "Min" means the lowest value where the pin is guaranteed to be read as high.
 3. "Max" means the highest value where the pin is guaranteed to be read as low.
 4. Although each I/O port can sink more than the test conditions (10mA at $V_{CC} = 5\text{V}$, 5mA at $V_{CC} = 3\text{V}$) under steady state conditions (non-transient), the sum of all I_{OL} (for all ports) should not exceed 60mA. If I_{OL} exceeds the test conditions, V_{OL} may exceed the related specification. Pins are not guaranteed to sink current greater than the listed test condition.
 5. Although each I/O port can source more than the test conditions (10mA at $V_{CC} = 5\text{V}$, 5mA at $V_{CC} = 3\text{V}$) under steady state conditions (non-transient), the sum of all I_{OH} (for all ports) should not exceed 60mA. If I_{OH} exceeds the test condition, V_{OH} may exceed the related specification. Pins are not guaranteed to source current greater than the listed test condition.
 6. The $\overline{\text{RESET}}$ pin must tolerate high voltages when entering and operating in programming modes and, as a consequence, has a weak drive strength as compared to regular I/O pins.
 7. Values are with external clock. Power Reduction is enabled (PRR = 0xFF) and there is no I/O drive.
 8. BOD Disabled.

1.3 Clock Characteristics

1.3.1 Accuracy of Calibrated Internal Oscillator

It is possible to manually calibrate the internal oscillator to be more accurate than default factory calibration.

Note: The oscillator frequency depends on temperature and voltage. Voltage and temperature characteristics can be found in [Figure 2-42 on page 28](#) and [Figure 2-43 on page 28](#).

Table 1-2. Calibration Accuracy of Internal Oscillator

Calibration Method	Target Frequency	V _{CC}	Temperature	Accuracy at given voltage & temperature ⁽¹⁾
Factory Calibration	8.0MHz	3V	25°C	±10%
User Calibration	Fixed frequency within: 7.3 – 8.1MHz	Fixed voltage within: 1.8V – 5.5V	Fixed temperature within: -40°C to +125°C	±1%

Notes: 1. Accuracy of oscillator frequency at calibration point (fixed temperature and fixed voltage).

1.4 System and Reset Characteristics

1.4.1 Enhanced Power-On Reset

Table 1-3. Characteristics of Enhanced Power-On Reset. T_A = -40°C to +125°C

Symbol	Parameter	Min ⁽¹⁾	Typ ⁽¹⁾	Max ⁽¹⁾	Units
V _{POR}	Release threshold of power-on reset ⁽²⁾	1.1	1.4	1.7	V
V _{POA}	Activation threshold of power-on reset ⁽³⁾	0.6	1.3	1.7	V
SR _{ON}	Power-On Slope Rate	0.01			V/ms

Note: 1. Values are guidelines, only.
2. Threshold where device is released from reset when voltage is rising.
3. The Power-on Reset will not work unless the supply voltage has been below V_{POA}.

1.5 ADC Characteristics

Table 1-4. ADC Characteristics, Single Ended Channels. T = -40°C to +125°C

Symbol	Parameter	Condition	Min	Typ	Max	Units
	Resolution				10	Bits
	Absolute accuracy (Including INL, DNL, and Quantization, Gain and Offset Errors)	$V_{REF} = 4V, V_{CC} = 4V,$ ADC clock = 200kHz		2		LSB
		$V_{REF} = 4V, V_{CC} = 4V,$ ADC clock = 1 MHz		3		LSB
		$V_{REF} = 4V, V_{CC} = 4V,$ ADC clock = 200kHz Noise Reduction Mode		1.5		LSB
		$V_{REF} = 4V, V_{CC} = 4V,$ ADC clock = 1MHz Noise Reduction Mode			2.5	LSB
	Integral Non-Linearity (INL) (Accuracy after Offset and Gain Calibration)	$V_{REF} = 4V, V_{CC} = 4V,$ ADC clock = 200kHz		1		LSB
	Differential Non-linearity (DNL)	$V_{REF} = 4V, V_{CC} = 4V,$ ADC clock = 200kHz		0.5		LSB
	Gain Error	$V_{REF} = 4V, V_{CC} = 4V,$ ADC clock = 200kHz		2.5		LSB
	Offset Error	$V_{REF} = 4V, V_{CC} = 4V,$ ADC clock = 200kHz		1.5		LSB
	Conversion Time	Free Running Conversion	13		260	μs
	Clock Frequency		50		1000	kHz
A_{VCC}	Analog Supply Voltage		$V_{CC} - 0.3$		$V_{CC} + 0.3$	V
A_{REF}	External Voltage Reference	Single Ended Conversions	2.0		A_{VCC}	V
		Differential Conversions	2.0		$A_{VCC} - 1.0$	V
V_{IN}	Input Voltage	Single Ended Conversions	GND		V_{REF}	
		Differential Conversions	0		$A_{VCC}^{(1)}$	V
	Input Bandwidth	Single Ended Conversions		38.5		kHz
		Differential Conversions		4		
V_{INT}	Internal 1.1V Reference		1.0	1.1	1.2	V
	Internal 2.56V Reference ⁽¹⁾	$V_{CC} > 3.0V$	2.3	2.56	2.8	V
R_{REF}	Reference Input Resistance			35		k Ω
R_{AIN}	Analog Input Resistance			100		M Ω
	ADC Conversion Output		0		1023	LSB

- Note: 1. V_{DIFF} must be below V_{REF}
2. Not tested in production.

1.6 Serial Programming Characteristics

Figure 1-1. Serial Programming Waveforms

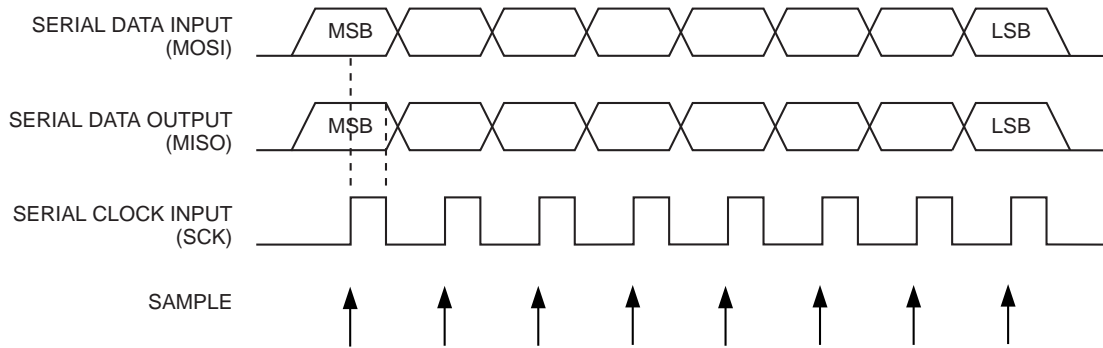

Figure 1-2. Serial Programming Timing

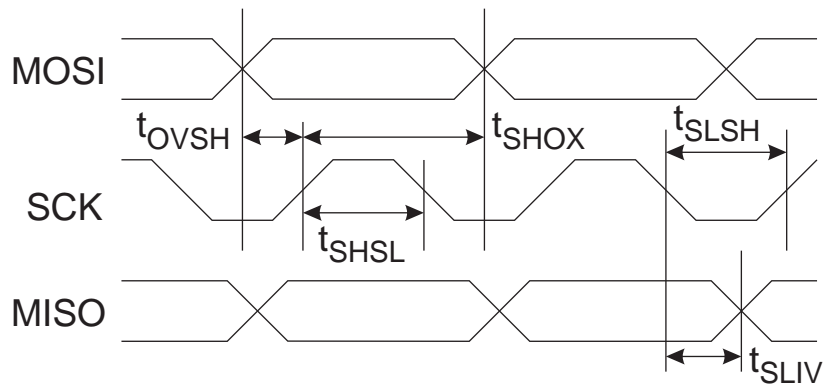

Table 1-5. Serial Programming Characteristics, $T_A = -40^\circ\text{C}$ to $+125^\circ\text{C}$, $V_{CC} = 1.8 - 5.5\text{V}$ (Unless Otherwise Noted)

Symbol	Parameter	Min	Typ	Max	Units
$1/t_{\text{CLCL}}$	Oscillator Frequency	0		4	MHz
t_{CLCL}	Oscillator Period	250			ns
$1/t_{\text{CLCL}}$	Oscillator Frequency ($V_{CC} = 4.5\text{V} - 5.5\text{V}$)	0		20	MHz
t_{CLCL}	Oscillator Period $V_{CC} = 4.5\text{V} - 5.5\text{V}$	50			ns
t_{SHSL}	SCK Pulse Width High	$2 t_{\text{CLCL}}^{(1)}$			ns
t_{SLSH}	SCK Pulse Width Low	$2 t_{\text{CLCL}}^{(1)}$			ns
t_{OVSH}	MOSI Setup to SCK High	t_{CLCL}			ns
t_{SHOX}	MOSI Hold after SCK High	$2 t_{\text{CLCL}}$			ns
t_{SLIV}	SCK Low to MISO Valid			100	ns

Note: 1. $2 t_{\text{CLCL}}$ for $f_{\text{ck}} < 12\text{MHz}$, $3 t_{\text{CLCL}}$ for $f_{\text{ck}} \geq 12\text{MHz}$

2. Typical Characteristics

The data contained in this section is largely based on simulations and characterization of similar devices in the same process and design methods. Thus, the data should be treated as indications of how the part will behave.

The following charts show typical behavior. These figures are not tested during manufacturing. During characterisation devices are operated at frequencies higher than test limits but they are not guaranteed to function properly at frequencies higher than the ordering code indicates.

This device has been characterised at temperatures of -40°C, 25°C, 85°C and 125°C.

All current consumption measurements are performed with all I/O pins configured as inputs and with internal pull-ups enabled. Current consumption is a function of several factors such as operating voltage, operating frequency, loading of I/O pins, switching rate of I/O pins, code executed, and ambient temperature. The dominating factors are operating voltage and frequency.

A sine wave generator with rail-to-rail output is used as clock source but current consumption in Power-Down mode is independent of clock selection. The difference between current consumption in Power-Down mode with Watchdog Timer enabled and Power-Down mode with Watchdog Timer disabled represents the differential current drawn by the Watchdog Timer.

The current drawn from pins with a capacitive load may be estimated (for one pin) as follows:

$$I_{CP} \approx V_{CC} \times C_L \times f_{SW}$$

where V_{CC} = operating voltage, C_L = load capacitance and f_{SW} = average switching frequency of I/O pin.

2.1 Current Consumption in Active Mode

Figure 2-1. Active Supply Current vs. V_{CC} (Internal Calibrated Oscillator, 8MHz)

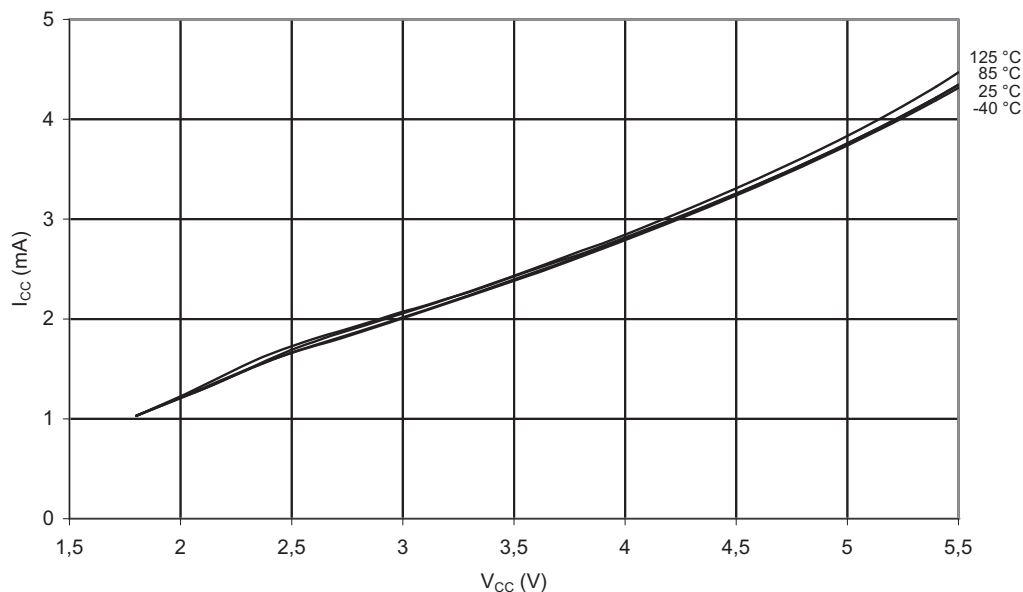

Figure 2-2. Active Supply Current vs. V_{CC} (Internal Calibrated Oscillator, 1MHz)

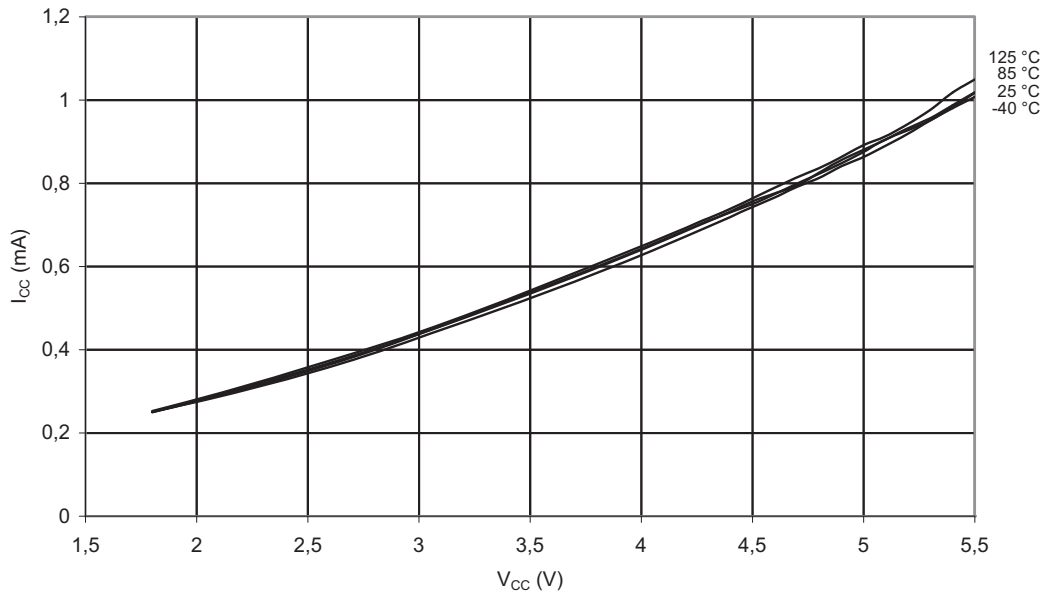
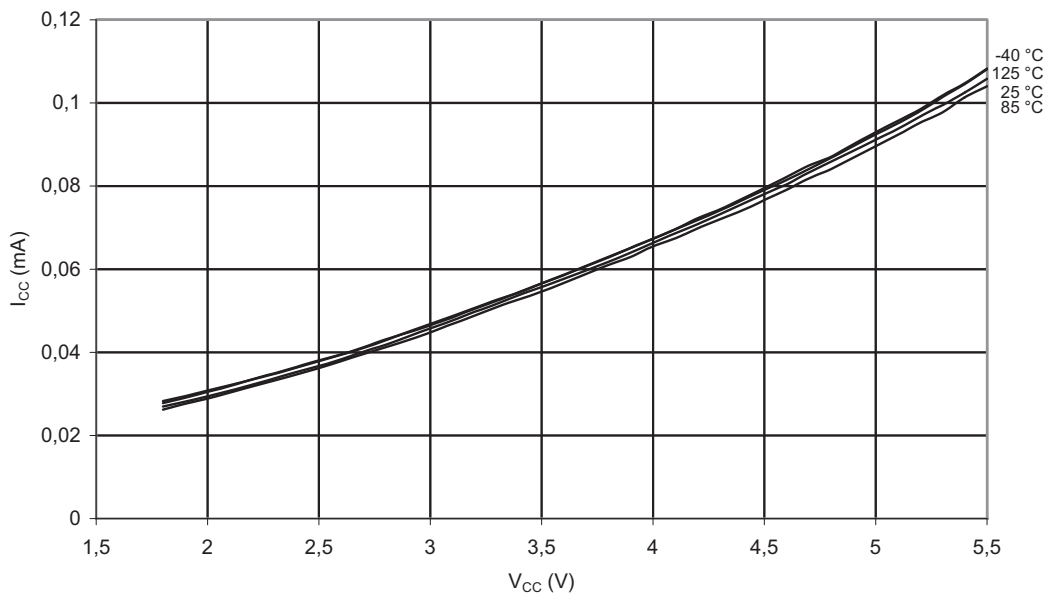

Figure 2-3. Active Supply Current vs. V_{CC} (Internal Calibrated Oscillator, 128kHz)



2.2 Current Consumption in Idle Mode

Figure 2-4. Idle Supply Current vs. V_{CC} (Internal Calibrated Oscillator, 8MHz)

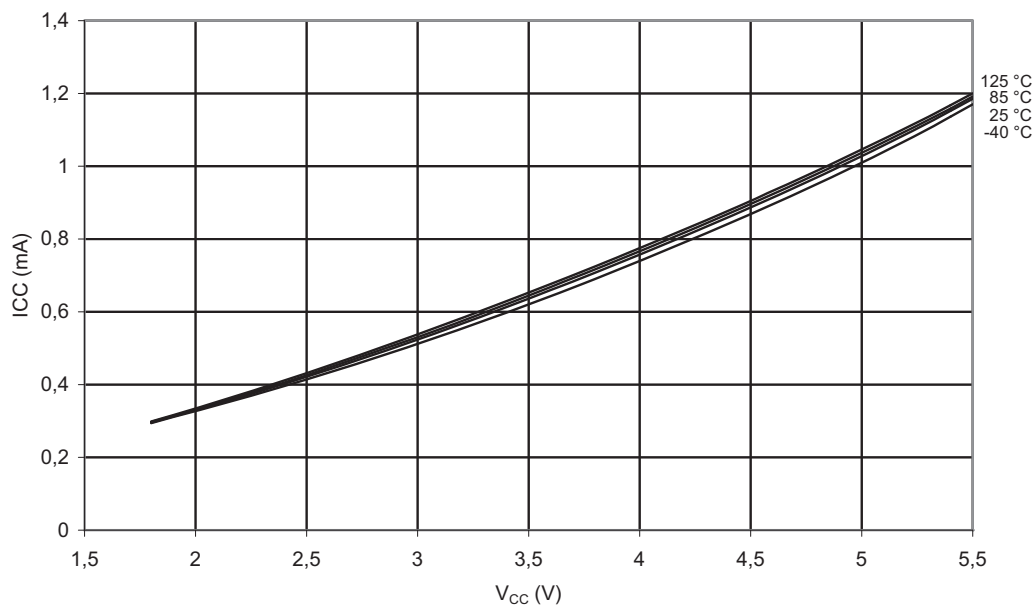

Figure 2-5. Idle Supply Current vs. V_{CC} (Internal Calibrated Oscillator, 1MHz)

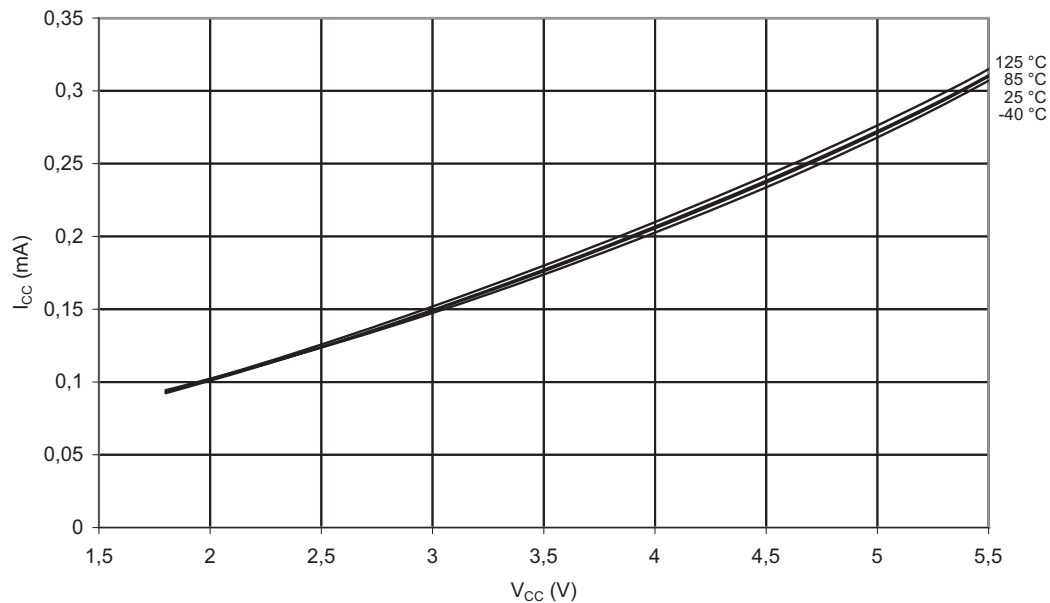
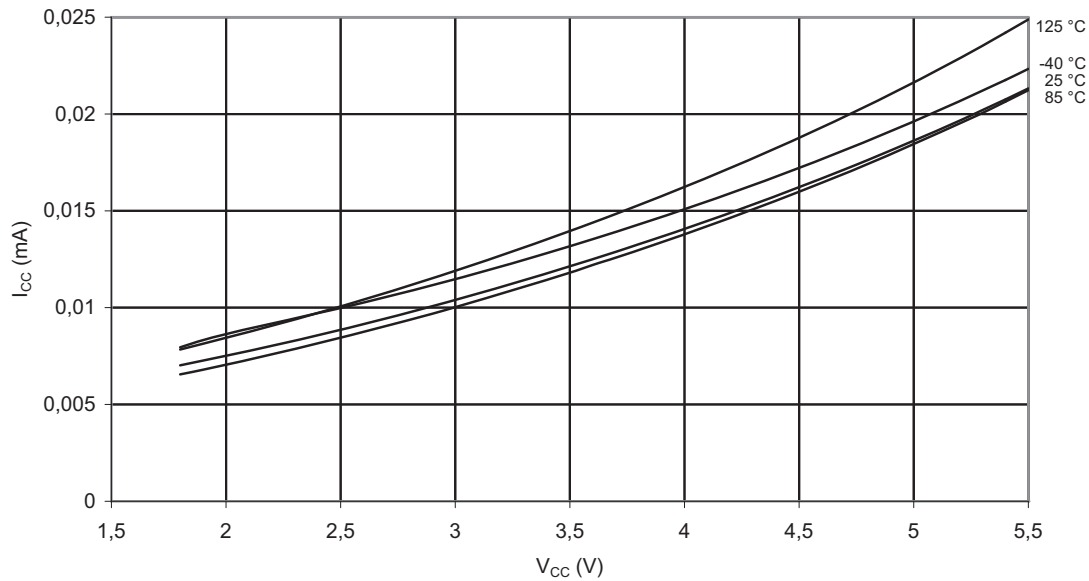

Figure 2-6. Idle Supply Current vs. V_{CC} (Internal Calibrated Oscillator, 128kHz)



2.3 Current Consumption in Power-Down Mode

Figure 2-7. Power-down Supply Current vs. V_{CC} (Watchdog Timer Disabled)

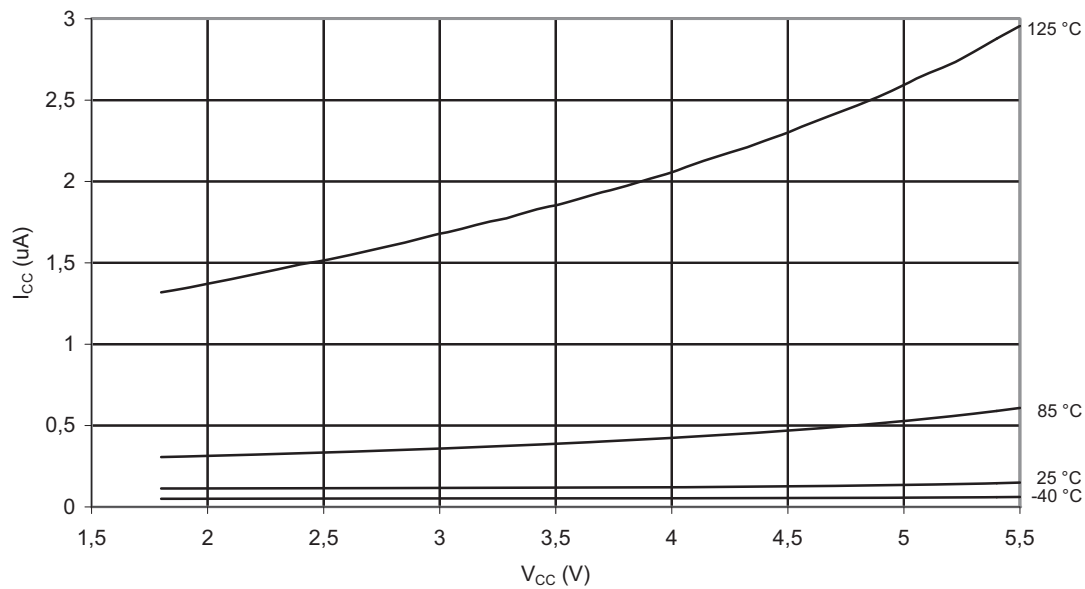
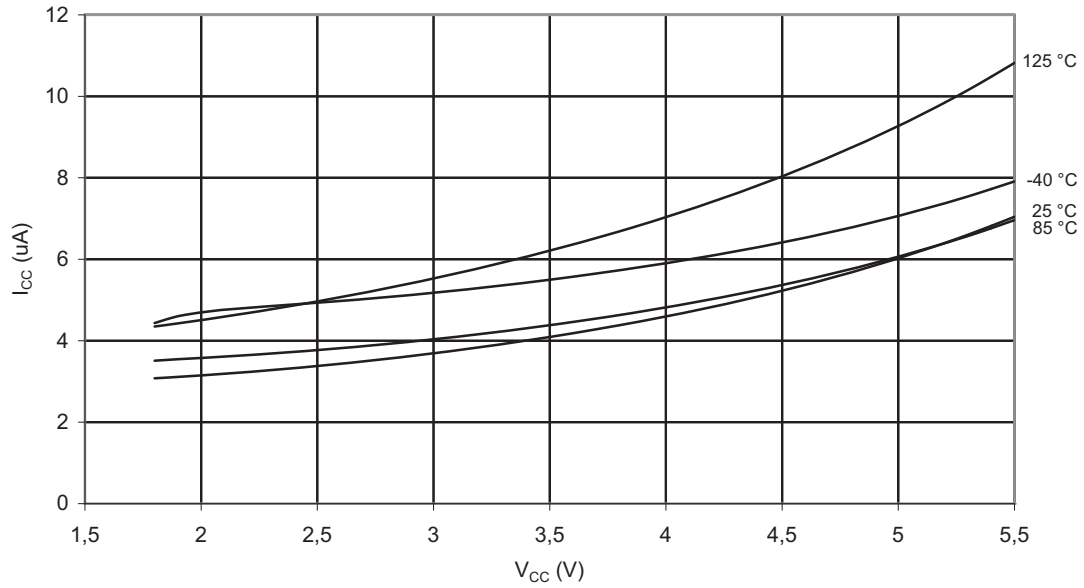

Figure 2-8. Power-down Supply Current vs. V_{CC} (Watchdog Timer Enabled)



2.4 Current Consumption of Peripheral Units

Figure 2-9. Brownout Detector Current vs. V_{CC}

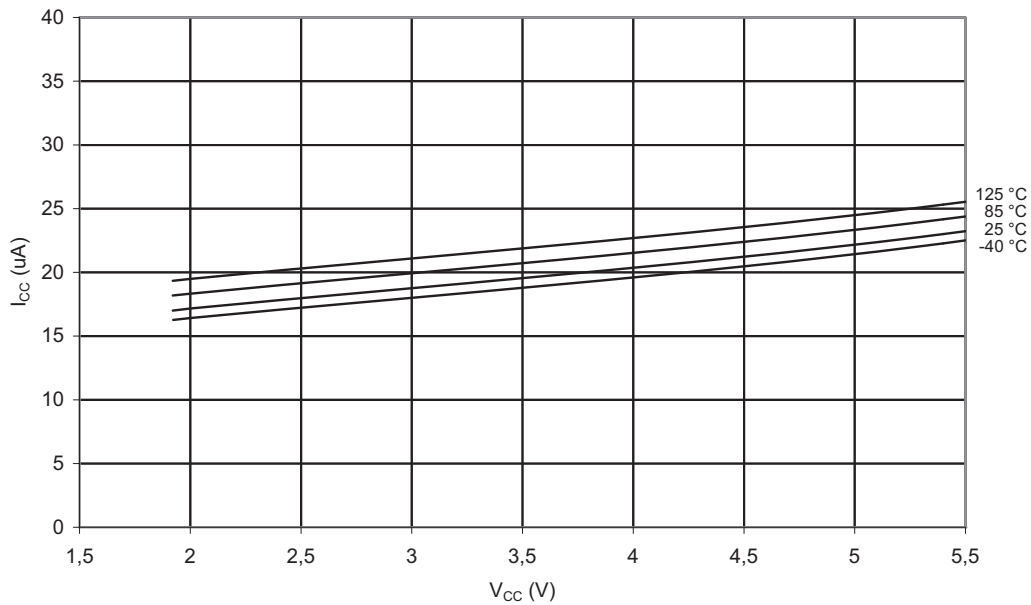
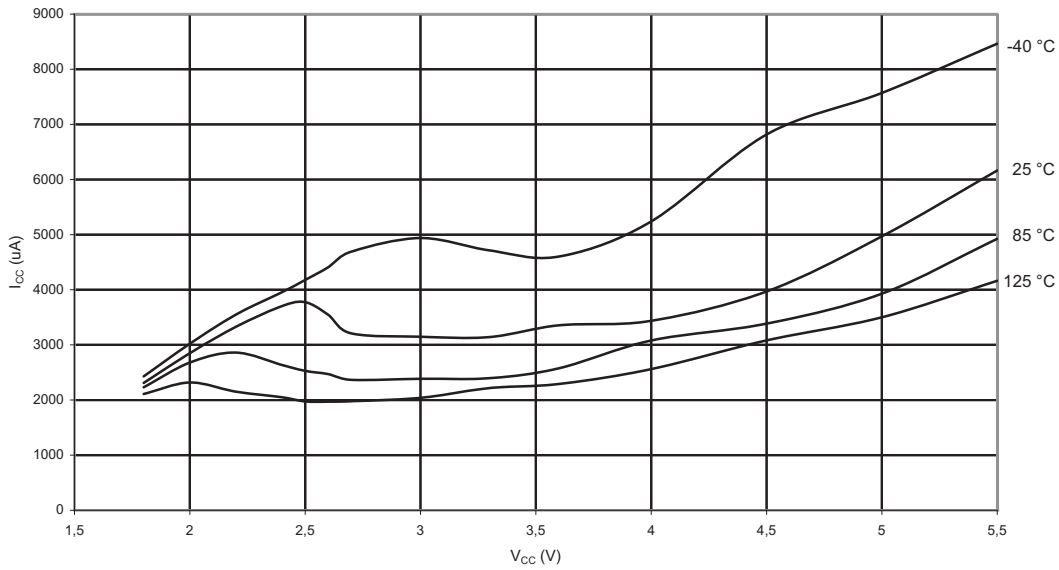

Figure 2-10. Programming Current vs. V_{CC}



2.5 Pull-up Resistors

Figure 2-11. Pull-Up Resistor Current vs. Input Voltage (I/O Pin, $V_{CC} = 1.8V$)

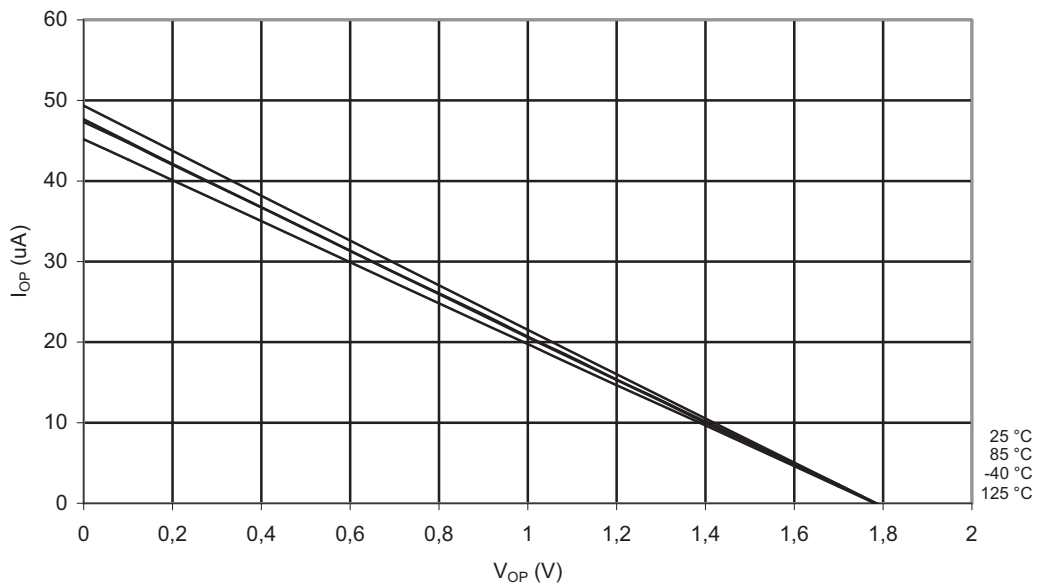

Figure 2-12. Pull-Up Resistor Current vs. Input Voltage (I/O Pin, $V_{CC} = 2.7V$)

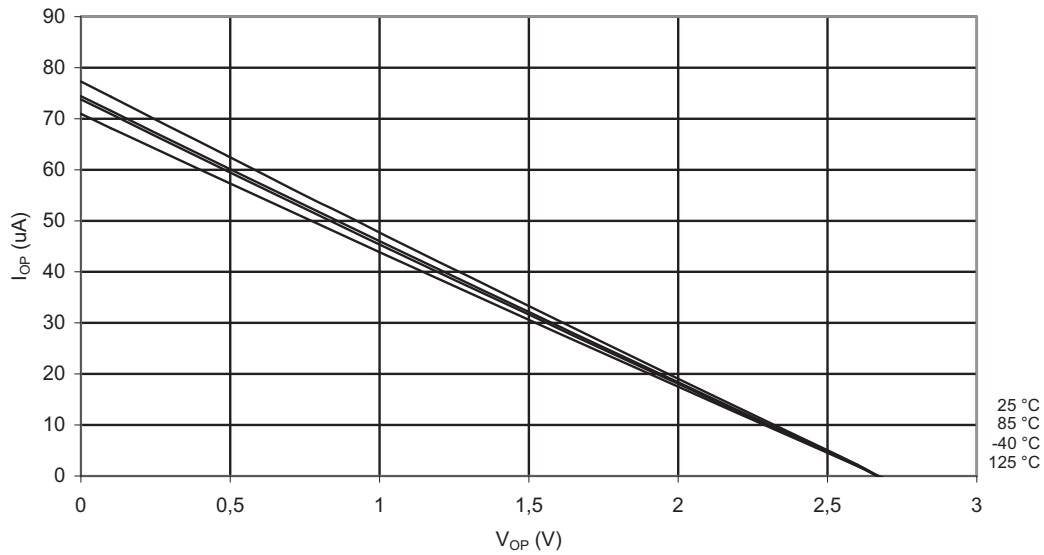

Figure 2-13. Pull-Up Resistor Current vs. Input Voltage (I/O Pin, $V_{CC} = 5V$)

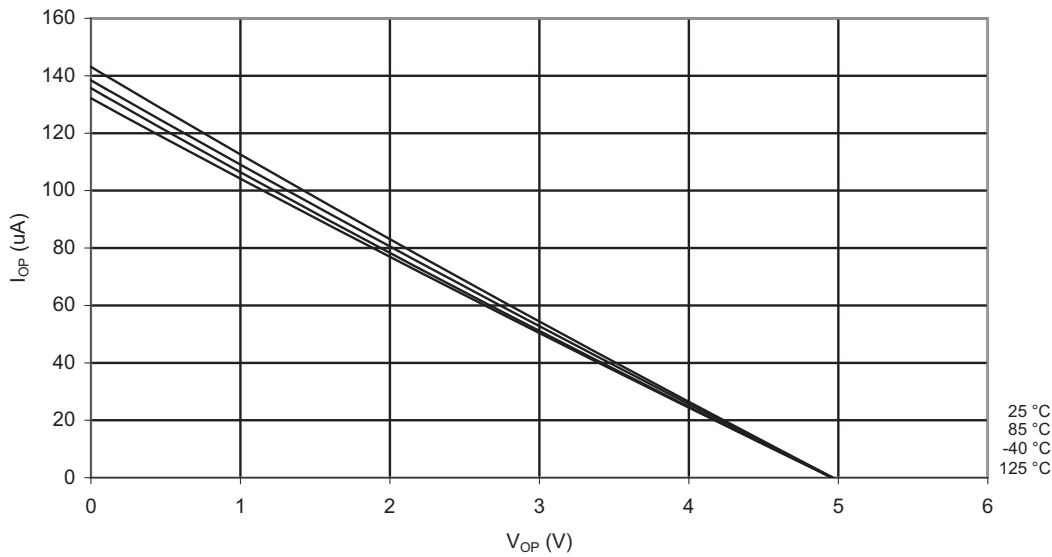

Figure 2-14. Pull-Up Resistor Current vs. Input Voltage (Reset Pin, $V_{CC} = 1.8V$)

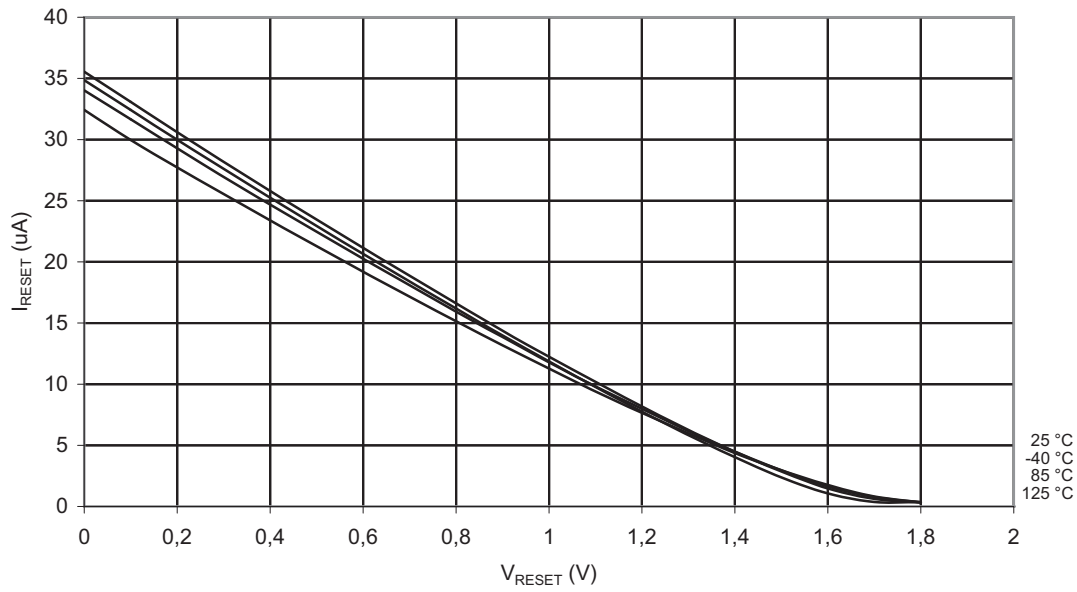

Figure 2-15. Pull-Up Resistor Current vs. Input Voltage (Reset Pin, $V_{CC} = 2.7V$)

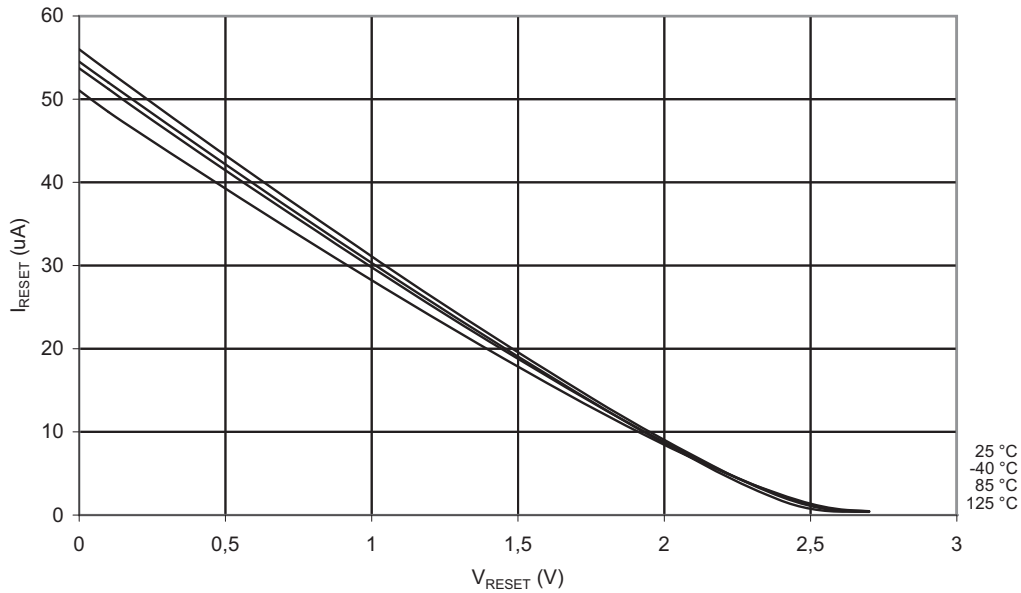
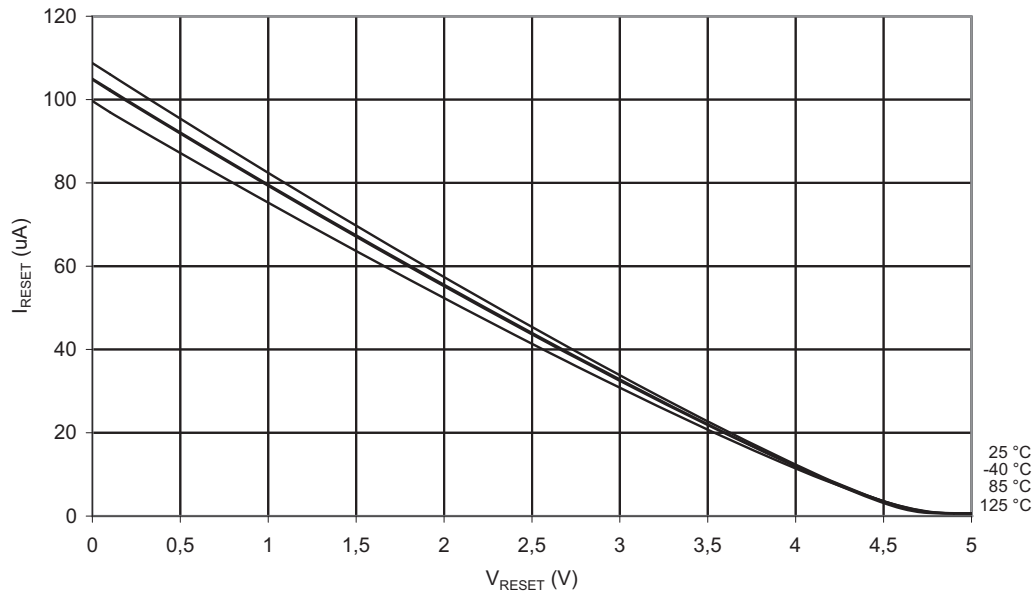

Figure 2-16. Pull-Up Resistor Current vs. Input Voltage (Reset Pin, $V_{CC} = 5V$)



2.6 Output Driver Strength

Figure 2-17. V_{OL} : Output Voltage vs. Sink Current (I/O Pin, $V_{CC} = 1.8V$)

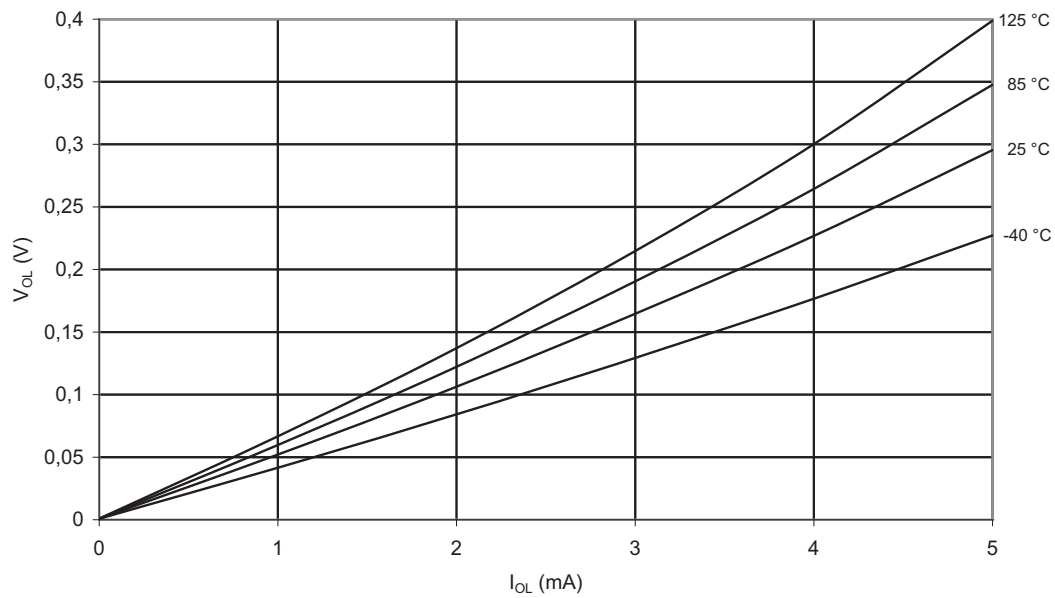

Figure 2-18. V_{OL} : Output Voltage vs. Sink Current (I/O Pin, $V_{CC} = 3V$)

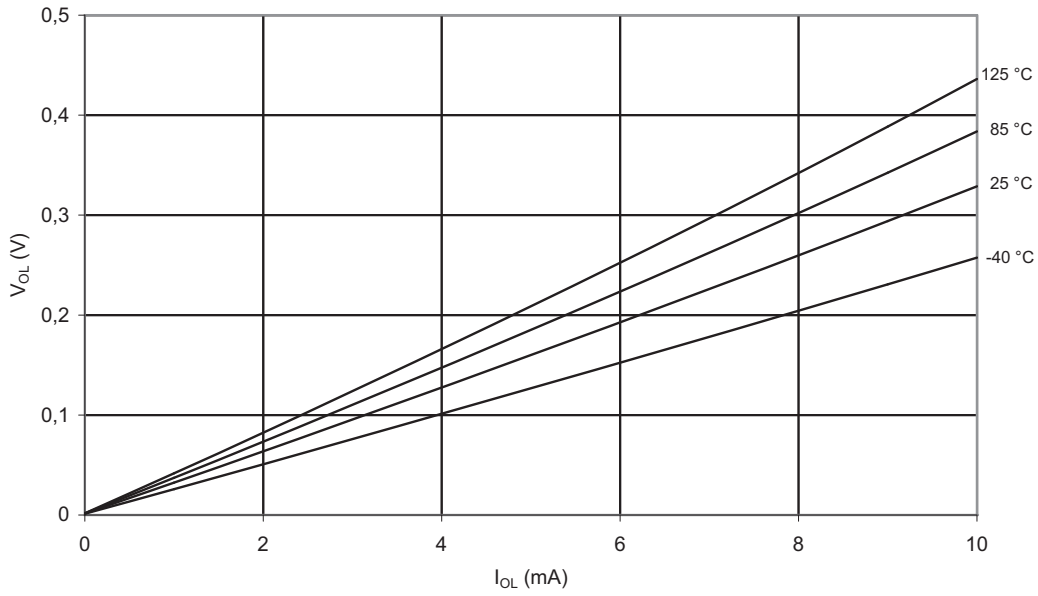

Figure 2-19. V_{OL} : Output Voltage vs. Sink Current (I/O Pin, $V_{CC} = 5V$)

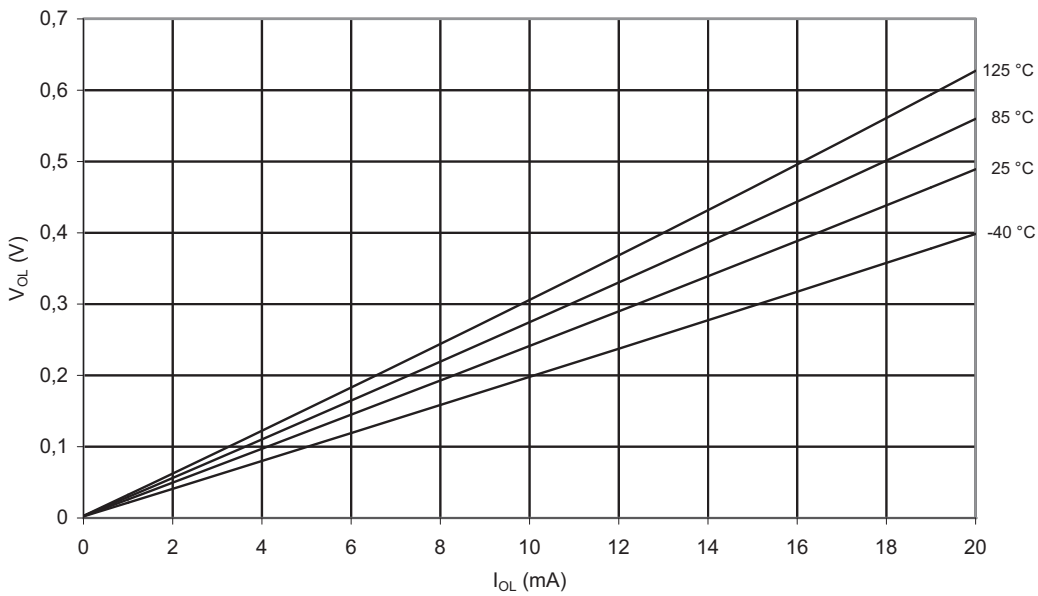

Figure 2-20. V_{OH} : Output Voltage vs. Source Current (I/O Pin, $V_{CC} = 1.8V$)

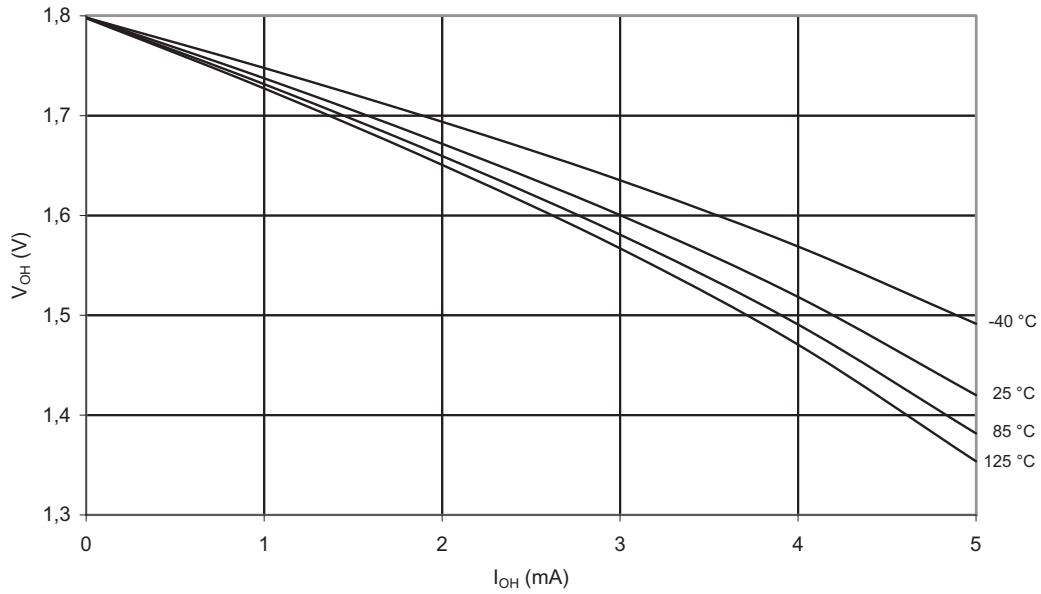

Figure 2-21. V_{OH} : Output Voltage vs. Source Current (I/O Pin, $V_{CC} = 3V$)

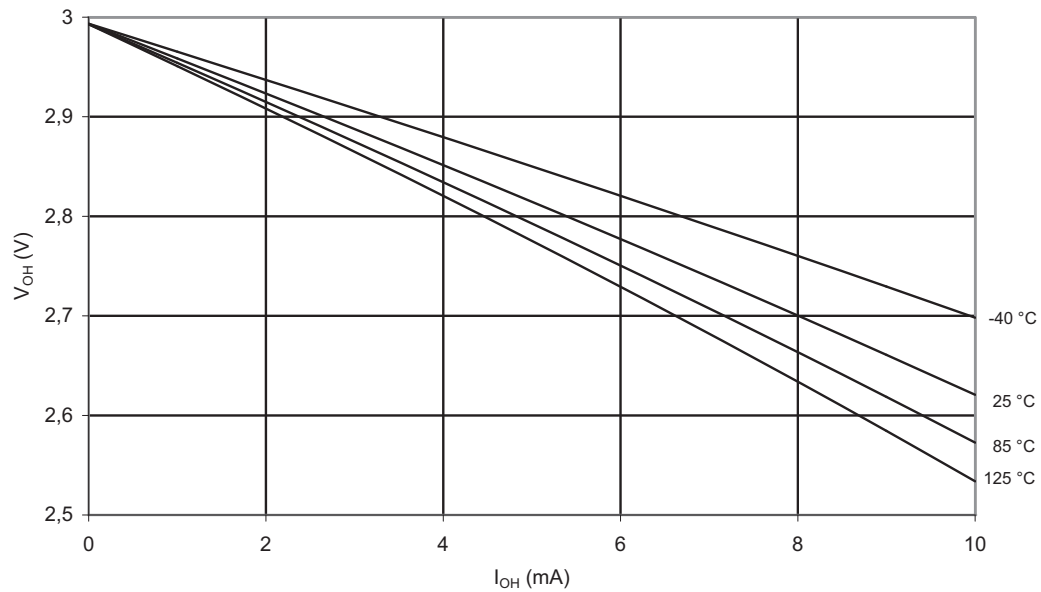

Figure 2-22. V_{OH} : Output Voltage vs. Source Current (I/O Pin, $V_{CC} = 5V$)

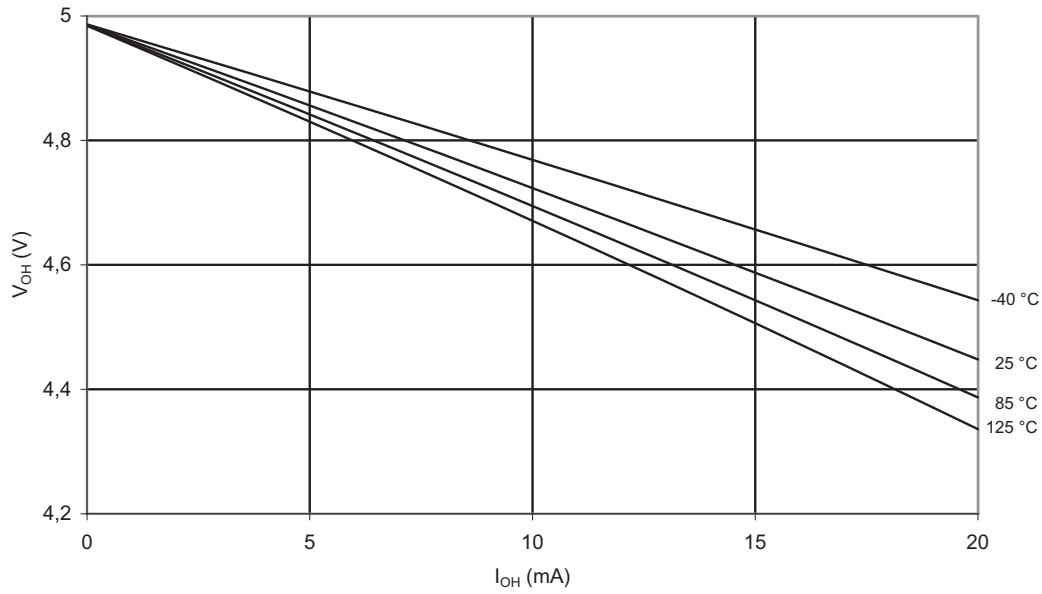

Figure 2-23. V_{OL} : Output Voltage vs. Sink Current (Reset Pin as I/O, $V_{CC} = 1.8V$)

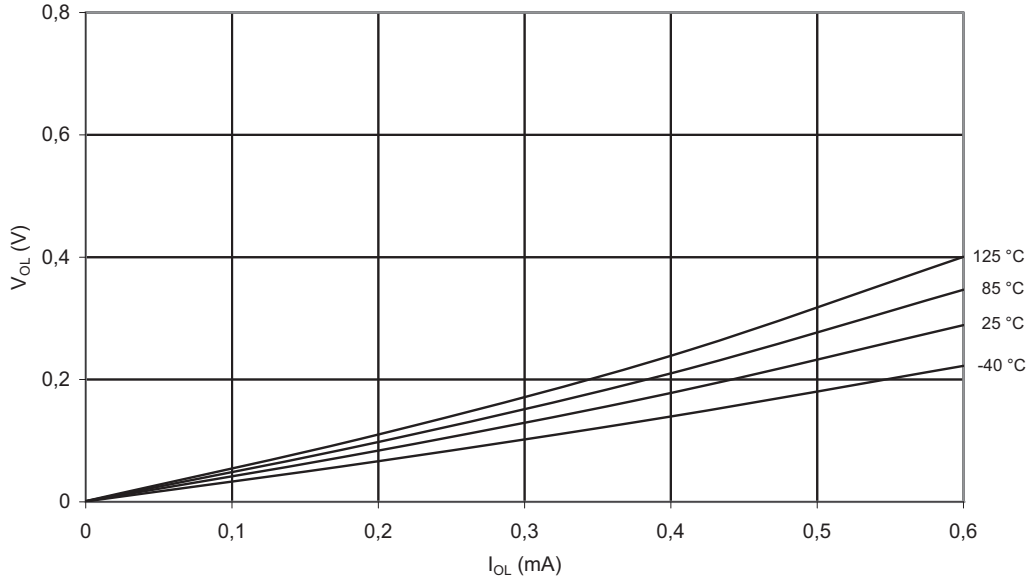

Figure 2-24. V_{OL} : Output Voltage vs. Sink Current (Reset Pin as I/O, $V_{CC} = 3V$)

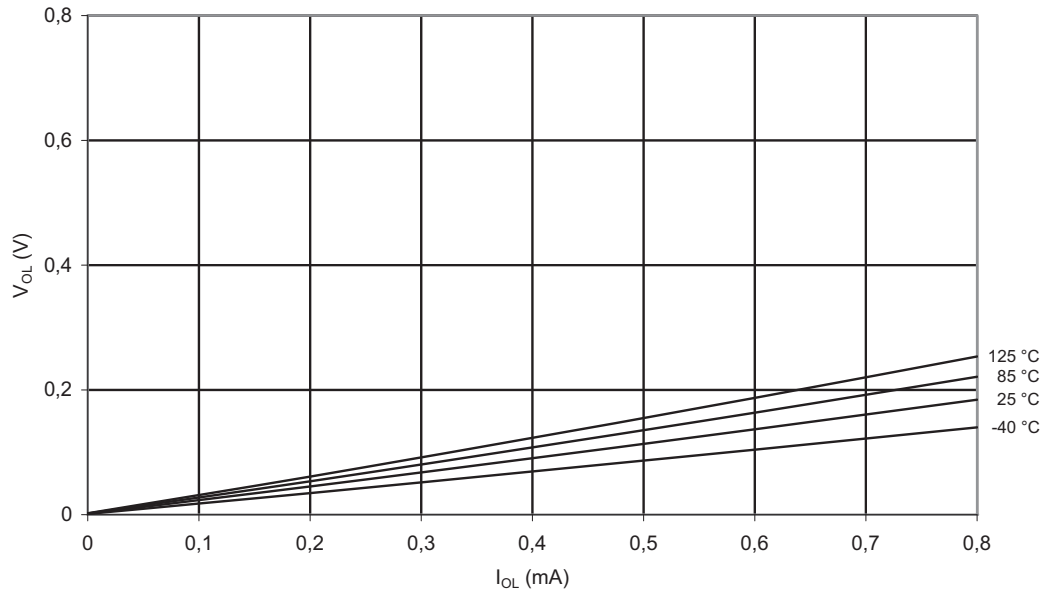

Figure 2-25. V_{OL} : Output Voltage vs. Sink Current (Reset Pin as I/O, $V_{CC} = 5V$)

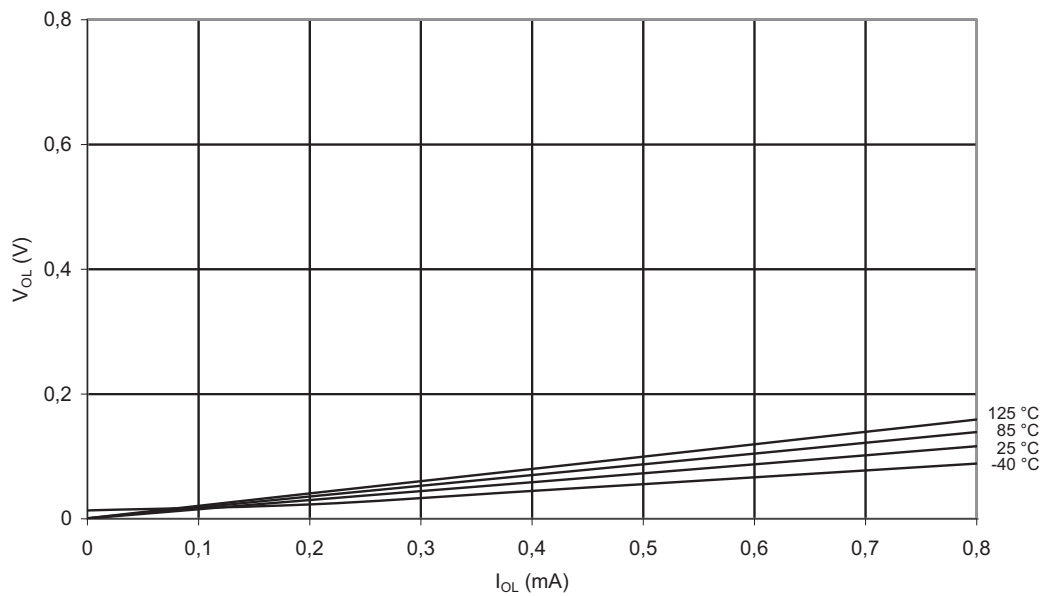

Figure 2-26. V_{OH} : Output Voltage vs. Source Current (Reset Pin as I/O, $V_{CC} = 1.8V$)

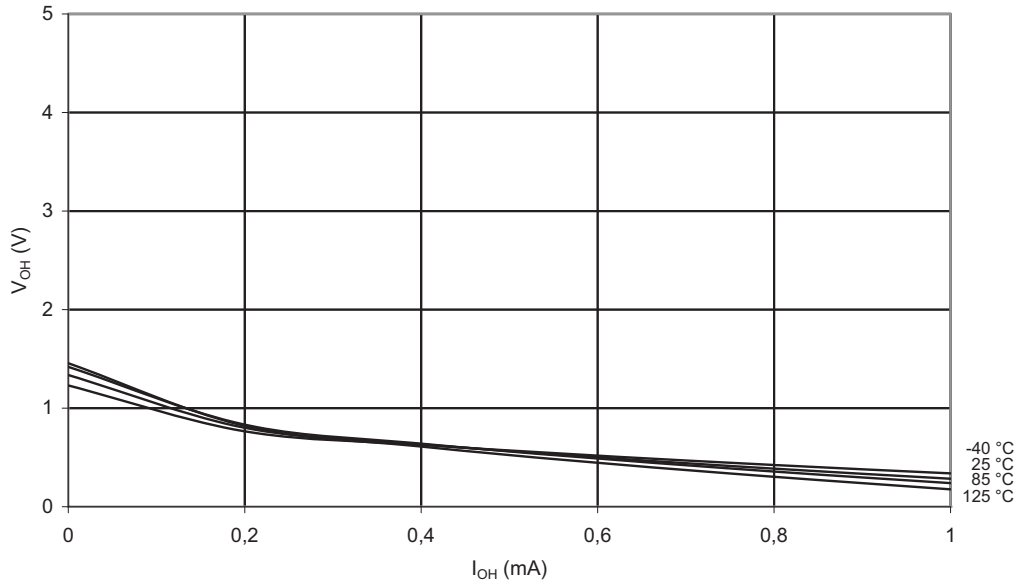

Figure 2-27. V_{OH} : Output Voltage vs. Source Current (Reset Pin as I/O, $V_{CC} = 3V$)

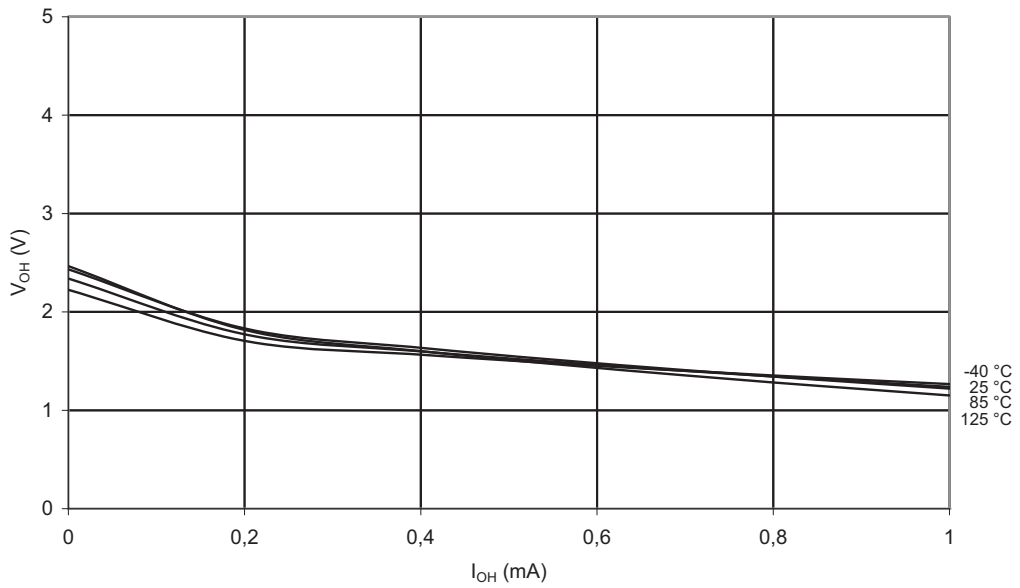
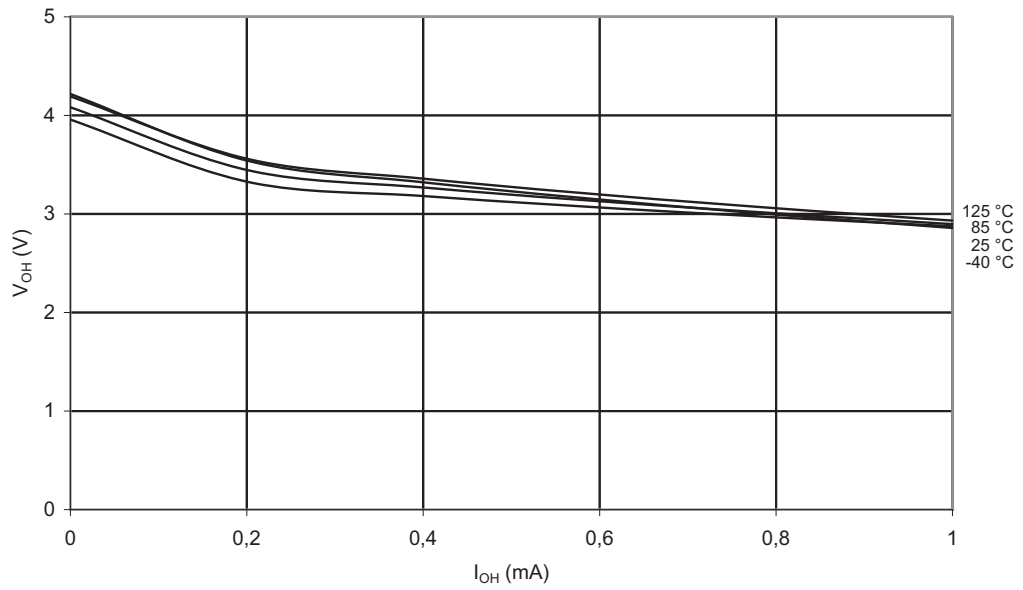

Figure 2-28. V_{OH} : Output Voltage vs. Source Current (Reset Pin as I/O, $V_{CC} = 5V$)



2.7 Input Thresholds and Hysteresis

Figure 2-29. V_{IH} : Input Threshold Voltage vs. V_{CC} (I/O Pin, Read as '1')

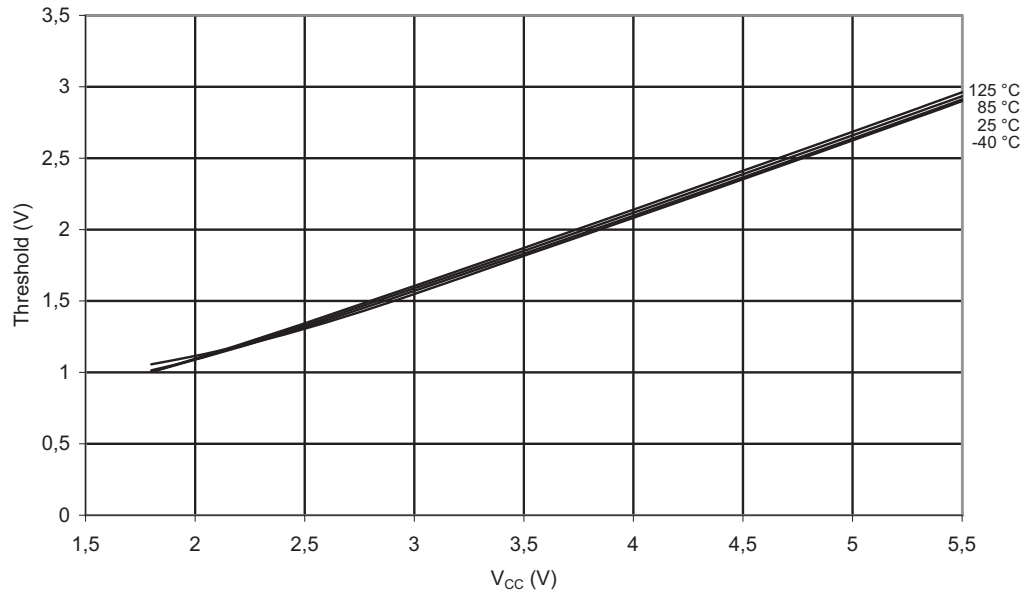

Figure 2-30. V_{IL} : Input Threshold Voltage vs. V_{CC} (I/O Pin, Read as '0')

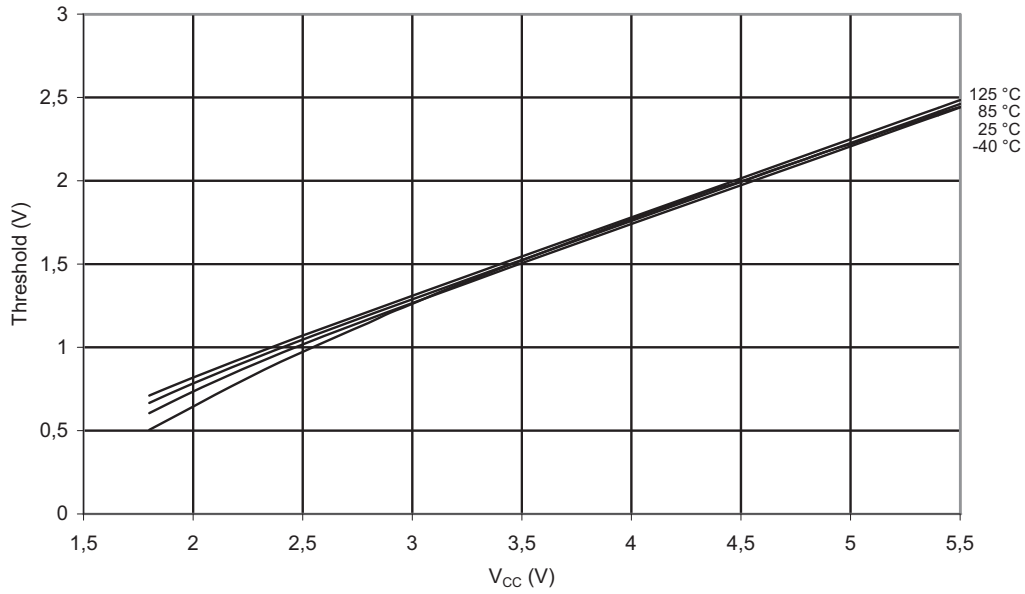

Figure 2-31. $V_{IH}-V_{IL}$: Input Hysteresis vs. V_{CC} (I/O Pin)

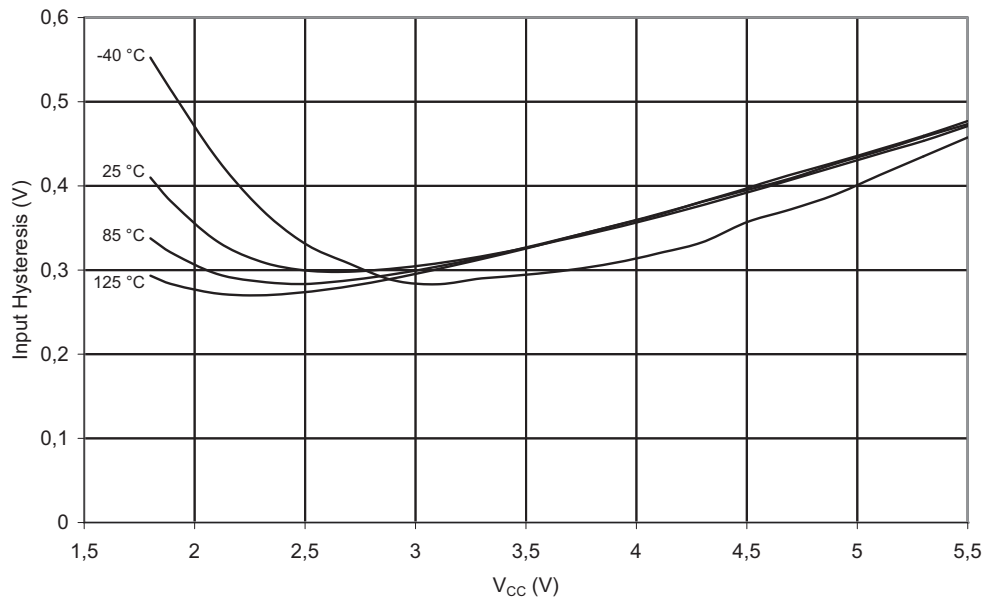

Figure 2-32. V_{IH} : Input Threshold Voltage vs. V_{CC} (Reset Pin, Read as '1')

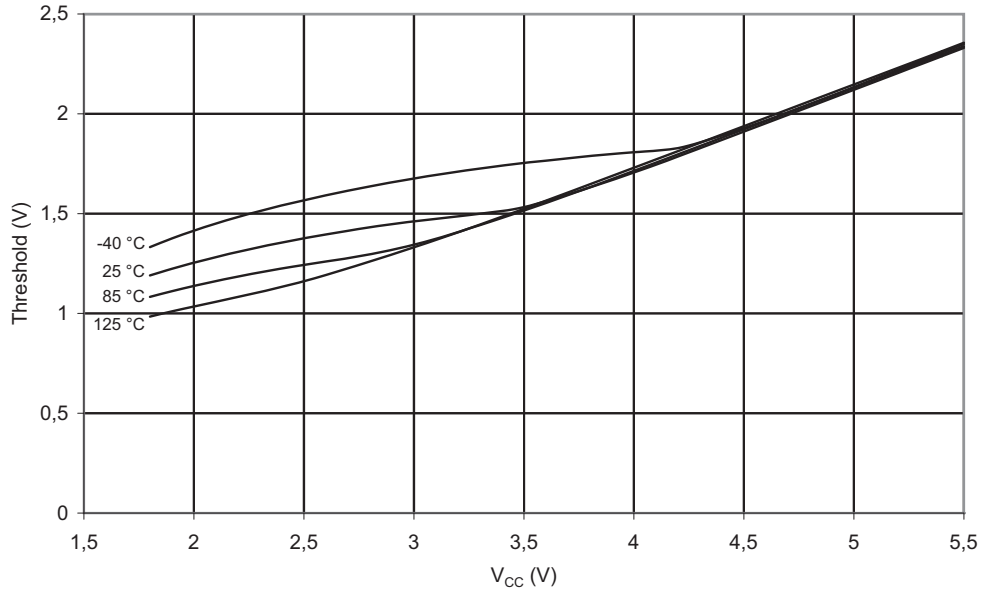

Figure 2-33. V_{IL} : Input Threshold Voltage vs. V_{CC} (Reset Pin, Read as '0')

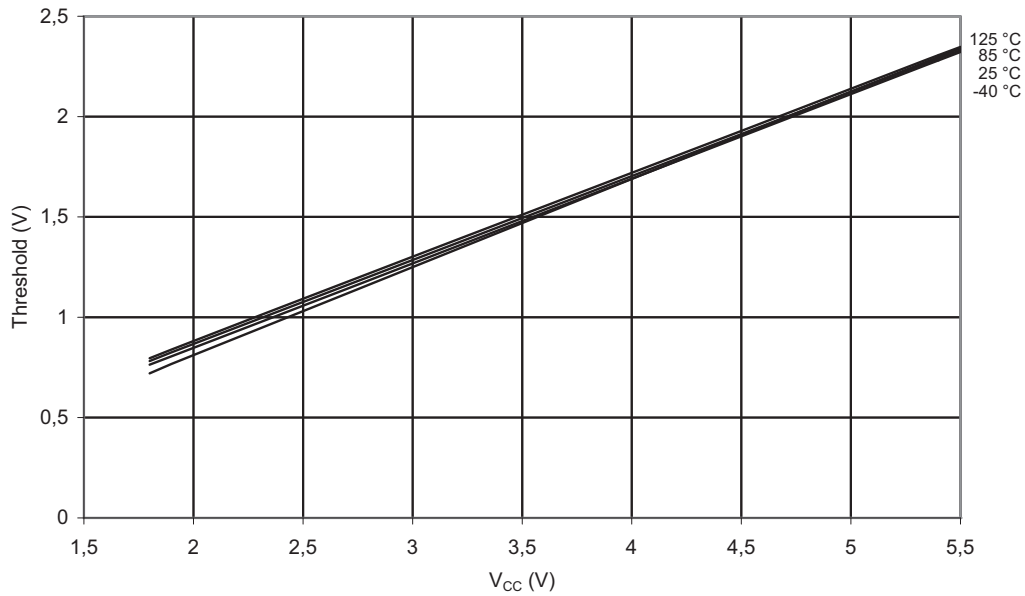
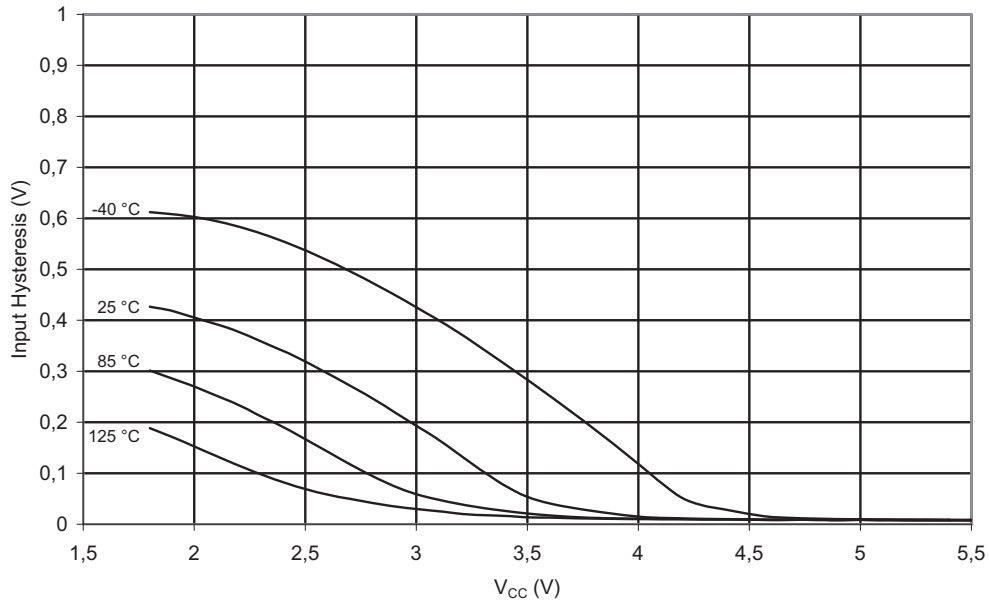

Figure 2-34. $V_{IH}-V_{IL}$: Input Hysteresis vs. V_{CC} (Reset Pin)



2.8 BOD, Bandgap and Reset

Figure 2-35. BOD Threshold vs. Temperature (BOD Level set to 4.3V)

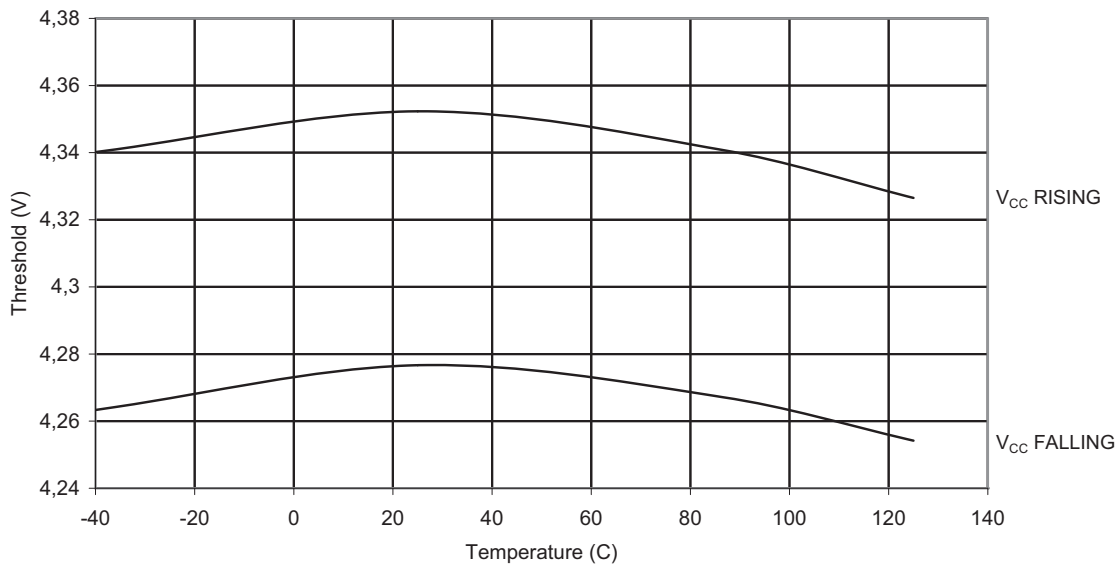

Figure 2-36. BOD Threshold vs. Temperature (BOD Level set to 2.7V)

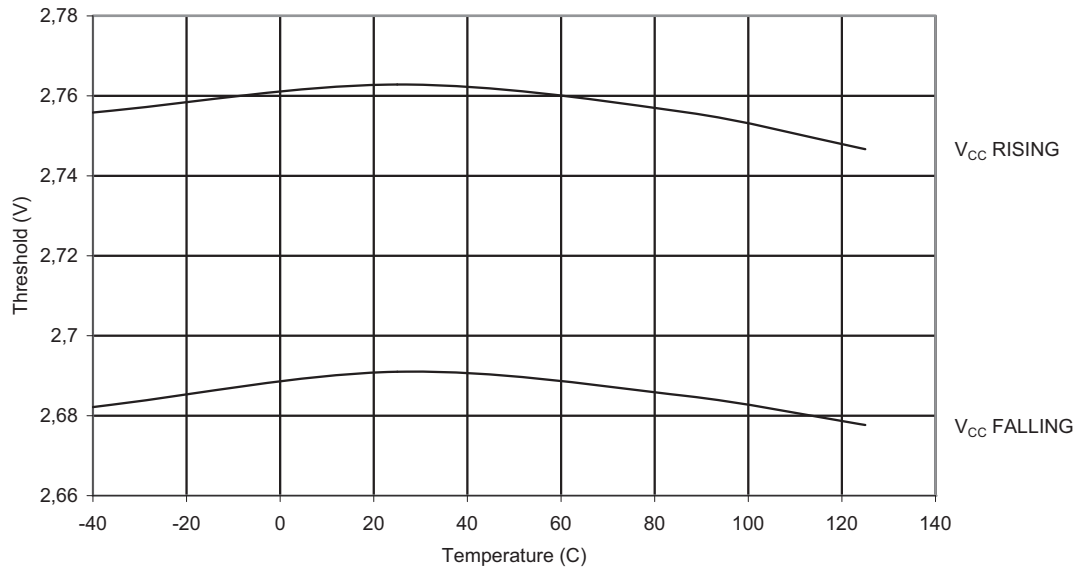

Figure 2-37. BOD Threshold vs. Temperature (BOD Level set to 1.8V)

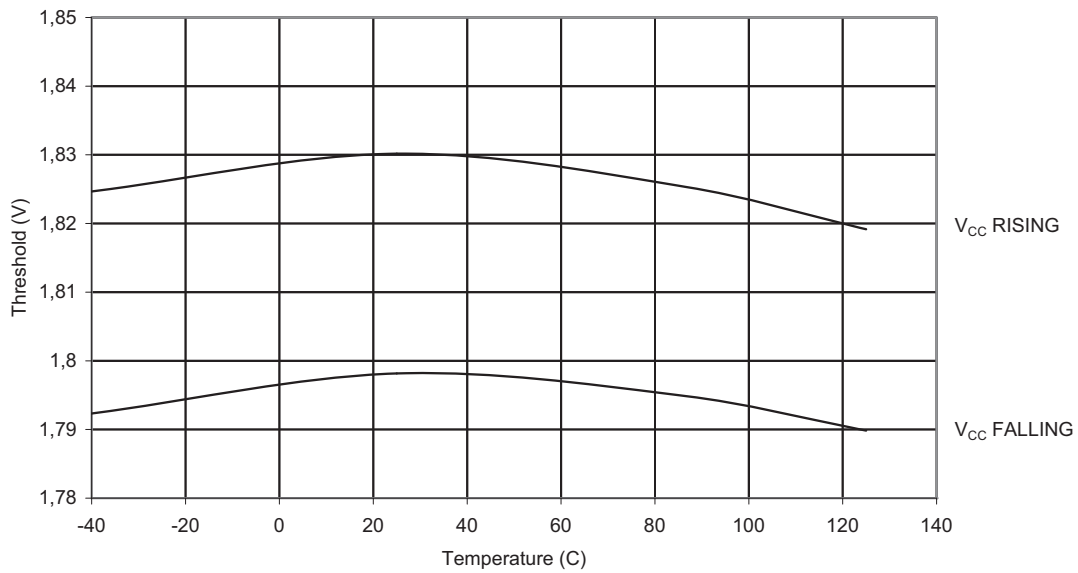

Figure 2-38. Bandgap Voltage vs. Supply Voltage.

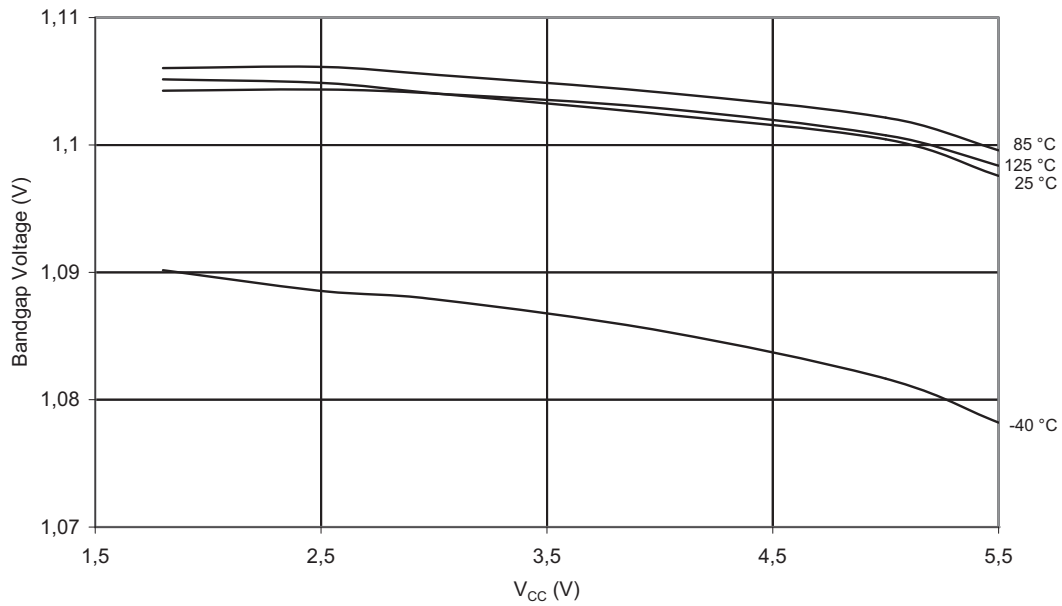
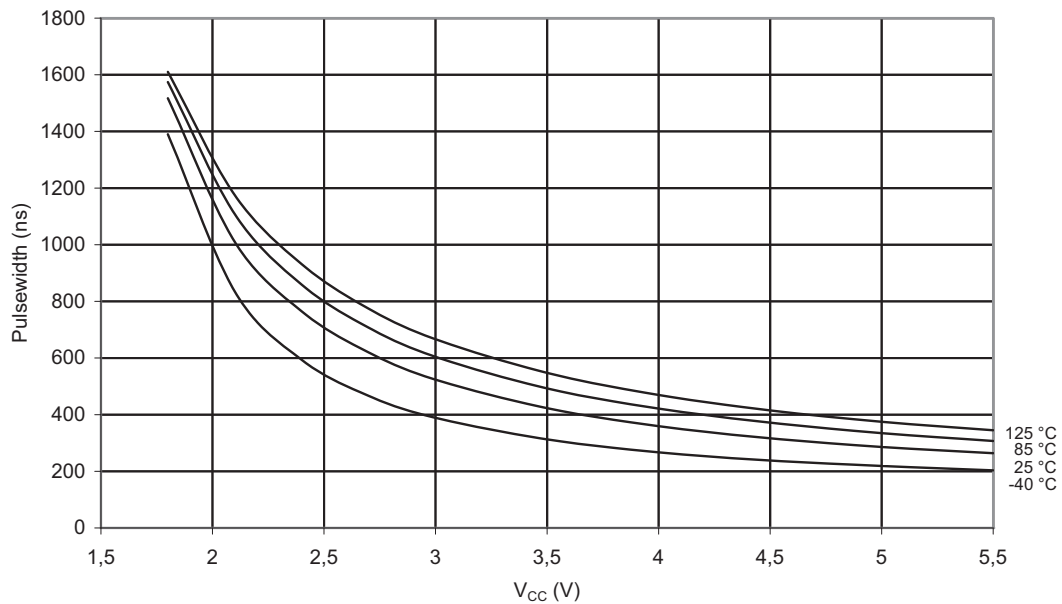

Figure 2-39. Minimum Reset Pulse Width vs. V_{CC}



2.9 Internal Oscillators

Figure 2-40. Frequency of Watchdog Oscillator vs. V_{CC}

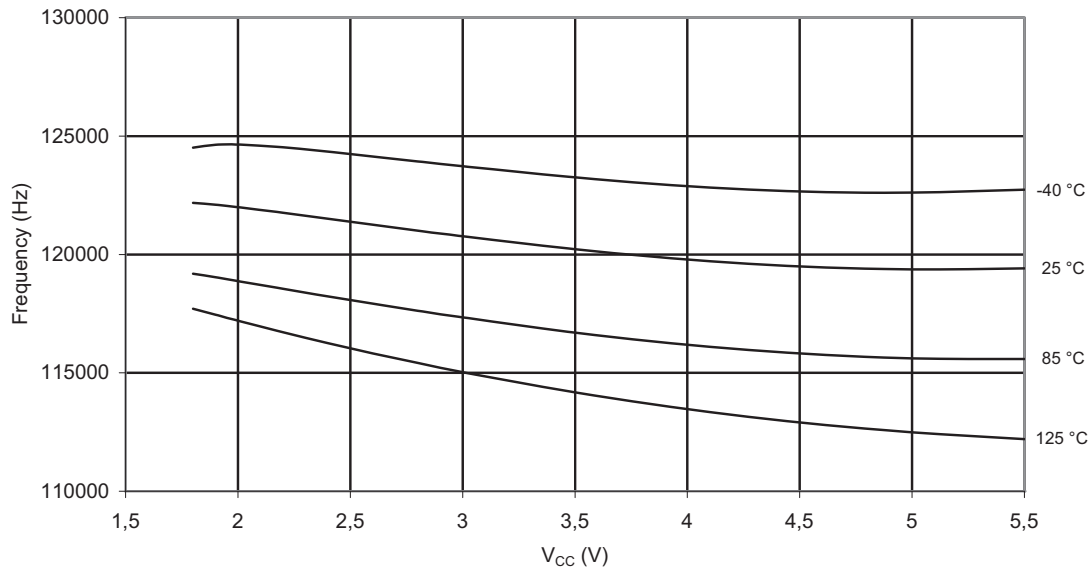

Figure 2-41. Frequency of Watchdog Oscillator vs. Temperature

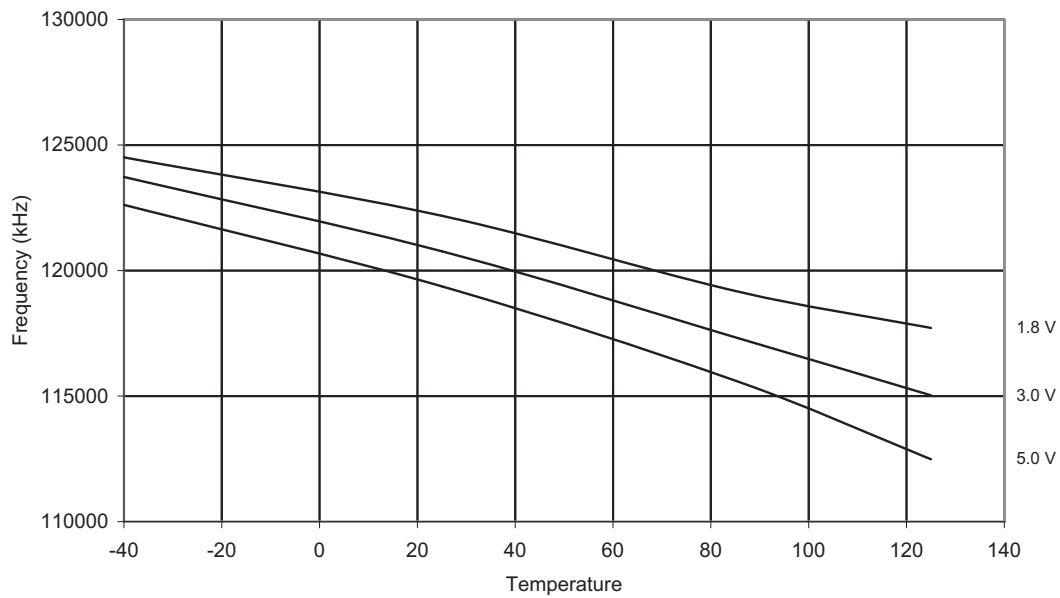

Figure 2-42. Frequency of Calibrated 8.0MHz Oscillator vs. V_{CC}

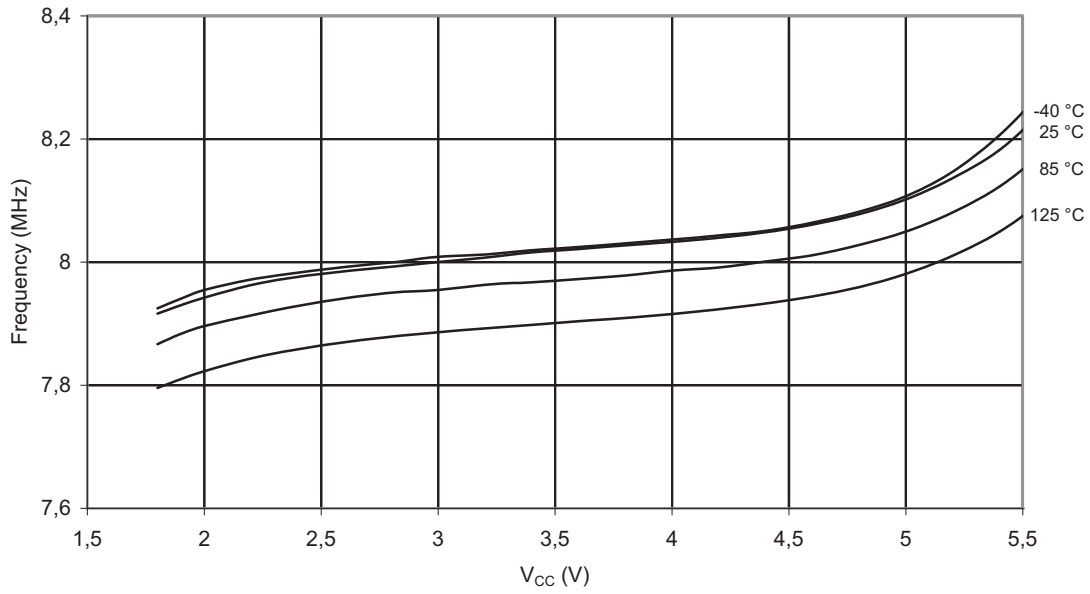

Figure 2-43. Frequency of Calibrated 8.0MHz Oscillator vs. Temperature

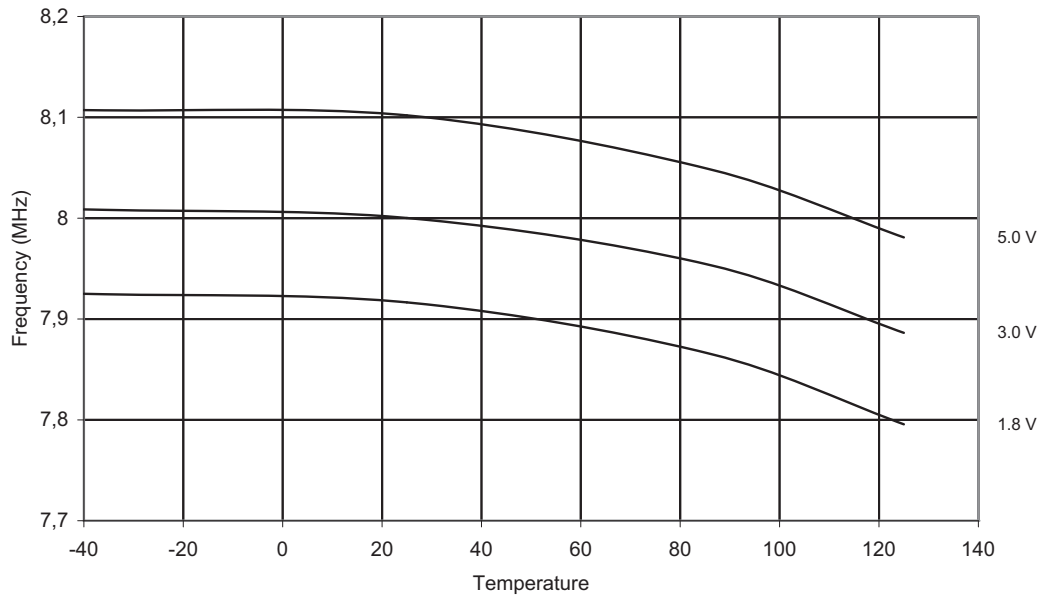
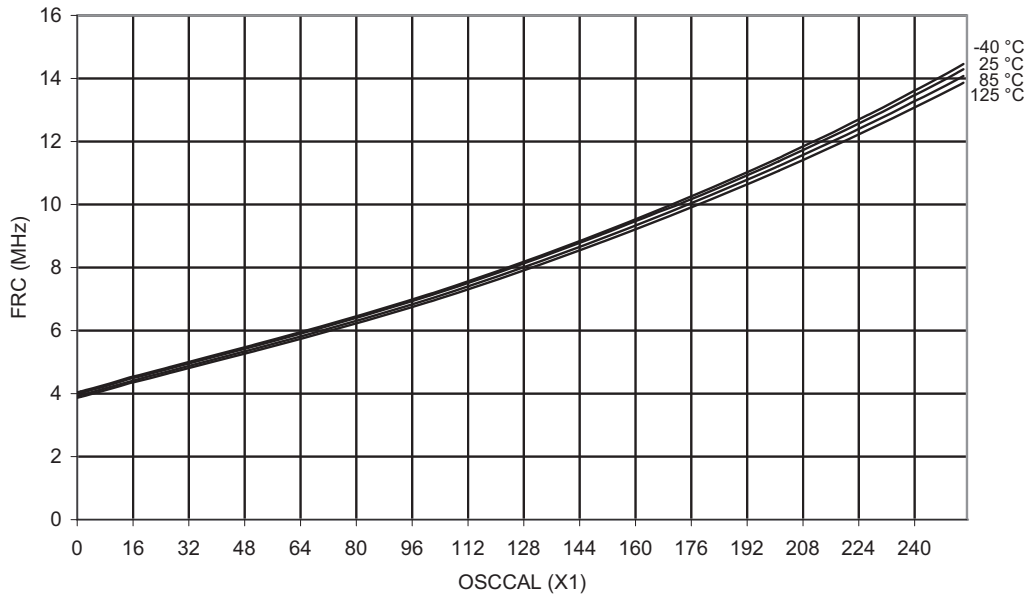

Figure 2-44. Frequency of Calibrated 8.0MHz Oscillator vs. OSCCAL Value



3. Ordering Information

Speed (MHz)	Power Supply	Ordering Code ⁽¹⁾	Package ⁽¹⁾	Operational Range
20	1.8 – 5.5V	ATtiny261A-MN ATtiny261A-MNR ⁽²⁾	32M1-A	Industrial (-40°C to +105°C)
20	1.8 – 5.5V	ATtiny261A-MF ATtiny261A-MFR ⁽²⁾	32M1-A	Industrial (-40°C to +125°C)

- Notes: 1. Pb-free packaging, complies to the European Directive for Restriction of Hazardous Substances (RoHS directive). Also halide-free and fully green.
2. Tape & Reel.

Package Type	
32M1-A	32-pad, 5 x 5 x 1.0mm Body, Lead Pitch 0.50mm, Micro Lead Frame Package (MLF)

4. Revision History

Revision No.	History
8197E-Appendix A-AVR-10/2014	Updated operating temperatures from 105°C to 125°C. Updated information at the last page. Added Ordering Information for Operating range (-40°C to +125°C)
8197D-Appendix A-AVR-02/2013	Updated ordering codes. Updated contact information at the last page.
8197C-Appendix A-AVR-08/2011	Updated contact information.
8197A-Appendix A-AVR-06/2010	Initial revision.

Atmel®, Atmel logo and combinations thereof, Enabling Unlimited Possibilities, and others are registered trademarks or trademarks of Atmel Corporation in U.S. and other countries. Other terms and product names may be trademarks of others.

DISCLAIMER: The information in this document is provided in connection with Atmel products. No license, express or implied, by estoppel or otherwise, to any intellectual property right is granted by this document or in connection with the sale of Atmel products. EXCEPT AS SET FORTH IN THE ATMEL TERMS AND CONDITIONS OF SALES LOCATED ON THE ATMEL WEBSITE, ATMEL ASSUMES NO LIABILITY WHATSOEVER AND DISCLAIMS ANY EXPRESS, IMPLIED OR STATUTORY WARRANTY RELATING TO ITS PRODUCTS INCLUDING, BUT NOT LIMITED TO, THE IMPLIED WARRANTY OF MERCHANTABILITY, FITNESS FOR A PARTICULAR PURPOSE, OR NON-INFRINGEMENT. IN NO EVENT SHALL ATMEL BE LIABLE FOR ANY DIRECT, INDIRECT, CONSEQUENTIAL, PUNITIVE, SPECIAL OR INCIDENTAL DAMAGES (INCLUDING, WITHOUT LIMITATION, DAMAGES FOR LOSS AND PROFITS, BUSINESS INTERRUPTION, OR LOSS OF INFORMATION) ARISING OUT OF THE USE OR INABILITY TO USE THIS DOCUMENT, EVEN IF ATMEL HAS BEEN ADVISED OF THE POSSIBILITY OF SUCH DAMAGES. Atmel makes no representations or warranties with respect to the accuracy or completeness of the contents of this document and reserves the right to make changes to specifications and products descriptions at any time without notice. Atmel does not make any commitment to update the information contained herein. Unless specifically provided otherwise, Atmel products are not suitable for, and shall not be used in, automotive applications. Atmel products are not intended, authorized, or warranted for use as components in applications intended to support or sustain life.

SAFETY-CRITICAL, MILITARY, AND AUTOMOTIVE APPLICATIONS DISCLAIMER: Atmel products are not designed for and will not be used in connection with any applications where the failure of such products would reasonably be expected to result in significant personal injury or death ("Safety-Critical Applications") without an Atmel officer's specific written consent. Safety-Critical Applications include, without limitation, life support devices and systems, equipment or systems for the operation of nuclear facilities and weapons systems. Atmel products are not designed nor intended for use in military or aerospace applications or environments unless specifically designated by Atmel as military-grade. Atmel products are not designed nor intended for use in automotive applications unless specifically designated by Atmel as automotive-grade.